



Vypilováno k dokonalosti

AJAX

zal. 1921

KATALOG

Catalog / Katalog / Каталог

YOUR DEALER: PRO EXPORT PLUS s.r.o.

V Korytech 3234/18a

Prague 10 – 100 00

Czech republic

proexport@proexport.cz

+420 272 770 648

Catalogue of
AJAX PILNÍKY s.r.o.

Vypilováno k dokonalosti Tuned to perfection

CZ

Jsme tradiční výrobci pilníků, rašplí a ocílek špičkové kvality. Při výrobě dbáme především na zručnost našich pracovníků, kvalitní materiály a vlastní tradici, z které čerpáme již 100 let. V současnosti nabízíme našim zákazníkům více než tisíc různých položek z našeho stálého sortimentu i výrobu různých specialit na základě přání klienta.

Kromě tradičních produktů u nás najdete i moderní výrobky z vlastní CNC dílny.

Jsme rodinná firma zakládající si na individuálním přístupu ke každému projektu, bez ohledu na jeho velikost.

EN

We are a traditional manufacturer of top-quality files, rasps and sharpening steels.

Our main priorities when producing our tools are the skill of our staff, quality materials and our own tradition, which dates back 100 years. We currently offer our customers more than a thousand different items from our permanent range and also manufacture various specialties as requested by the client.

In addition to our traditional tools, we also offer modern products from our own CNC workshop.

We are a family company that takes an individual approach to each project, regardless of its size.

DE

Wir sind ein traditioneller Hersteller von hochwertigen Feilen, Raspeln und Messerschärfnern.

Bei der Produktion achten wir besonders auf die Geschicklichkeit unserer Mitarbeiter, hochwertige Materialien und unsere eigene Tradition, aus der wir seit 100 Jahren schöpfen. Gegenwärtig bieten wir unseren Kunden mehr als tausend verschiedene Artikel aus unserem permanenten Sortiment und die Herstellung verschiedener Spezialitäten nach Kundenwunsch.

Neben traditionellen Produkten finden Sie auch moderne Produkte aus unserer eigenen CNC-Werkstatt.

Wir sind ein Familienunternehmen, das auf einem individuellen Ansatz für jedes Projekt basiert, unabhängig von seiner Größe.

RU

Мы являемся традиционным производителем напильников, рашпелей и стальных брусков высочайшего качества. Во время производства мы уделяем особое внимание мастерству наших работников, качественным материалам и традициям нашей фирмы, которых мы придерживаемся уже более 100 лет. В настоящее время мы предлагаем нашим заказчикам различную продукцию более тысячи наименований из нашего постоянного ассортимента и производство различных специальных изделий на основе запросов клиентов. Помимо традиционной продукции, у нас вы можете найти также современные изделия, произведенные с использованием станков с числовым программным управлением. Мы являемся семейным предприятием, основанным на



DÍLENSKÉ PILNÍKY ENGINEER'S FILES / WERKSTATTFEILEN / МАСТЕРСКИЕ НАПИЛЬНИКИ	7
DÍLENSKÉ PILNÍKY S ERGONOMICKÝM DRŽADLEM ERGONOMIC ENGINEER'S FILES / WERKSTATTFEILEN-E / МАСТЕРСКИЕ НАПИЛЬНИКИ-Э	10
KLÍČOVÉ PILNÍKY KEY FILES / SCHLÜSSELFEILEN / КЛЮЧЕВЫЕ НАПИЛЬНИКИ	12
FRÉZOVANÉ PILNÍKY A PLÁTKY MILLED TOOTH FILES AND CAR BODY BLADES / FRÄSERFEILEN UND KAROSSERIEFEILENBLATT / ФРЕЗЕРОВАЛЬНЫЕ НАПИЛЬНИКИ И ЛОМТИКИ.....	14
STROJNÍ PILNÍKY MACHINE FILES / MASCHINENFEILEN / МАШИННЫЕ НАПИЛЬНИКИ.....	16
PILNÍKY NA OPRAVU ZÁVITŮ THREAD RESTORING FILES / GEWINDEFEILEN / ВОССТАНОВИТЕЛЬ РЕЗЬБЫ	19
JEHLOVÉ PILNÍKY NEEDLE FILES / NADELFEILEN / НАДФИЛИ	22
DIAMANTOVÉ JEHLVÉ PILNÍKY DIAMOND NEEDLE FILES / DIAMANT - NADELFEILEN / НАДФИЛИ АЛМАЗНЫЕ	26
PILNÍKY NA PILY SAW FILES / SCHÄRFFEILEN / НАПИЛЬНИКИ ДЛЯ ПИЛ	28
PRECIZNÍ PILNÍKY PRECISION FILES / PRÄZISIONSFEILEN / ПРЕЦИЗИОННЫЕ НАПИЛЬНИКИ	33
RYTECKÉ PILNÍKY SILNÉ DIE MAKERS' RIFFLERS / RIFFELFEILEN SCHWERE FORM / ФИГУРНЫЕ НАДФИЛИ СИЛЬНЫЕ	34
RYTECKÉ PILNÍKY SLABÉ DIE SINKERS' RIFFLERS / RIFFELFEILEN LEICHTE FORM / ФИГУРНЫЕ НАДФИЛИ СЛАБЫЕ	35
SKI PILNÍKY SKI FILES / SKIFEILEN / ЛЫЖИ	37
DRÁŽKOVACÍ PILNÍKY (CHECKERING) CHECKERING FILE / NUTENFEILE / ПАЗОВЫЕ НАПИЛЬНИКИ	39
PILNÍKY NA HUDEBNÍ NÁSTROJE FILES FOR MUSICAL INSTRUMENTS / FEILEN FÜR MUSIKINSTRUMENTE / НАПИЛЬНИКИ ДЛЯ МУЗЫКАЛЬНЫХ ИНСТРУМЕНТОВ.....	40
ROTAČNÍ PILNÍKY SLABÉ ROTARY FILES THIN / ROTATIONSFEILEN - DÜNN / БОРФРЕЗЫ ТОНКИЕ	43
ROTAČNÍ PILNÍKY SILNÉ ROTARY FILES THICK / ROTATIONSFEILEN - STARK / БОРФРЕЗЫ ТОЛСТЫЕ	44
ROTAČNÍ RAŠPLE ROTARY RASPS / ROTATIONSRASPELN / БОРФРЕЗЫ РАШПИЛЬНЫЕ	45
PODKOVÁŘSKÉ RAŠPLE HORSE RASPS / HUF RASPELN / ПОДКОВНЫЕ РАШПИЛЫ	46
RAŠPLE STROJNÍ SEK WOOD RASPS MACHINE CUT / RASPELN MASCHINENHIEB / РАШПИЛИ ПО ДЕРЕВУ МЕХАНИЧЕСКАЯ НАСЕЧКА	47
RAŠPLE RUČNÍ SEK WOOD RASPS HAND CUT / RASPELN HANDHIEB / РАШПИЛИ ПО ДЕРЕВУ РУЧНАЯ НАСЕЧКА	49
MODELÁŘSKÉ RAŠPLE RIFFLER RASPS FOR WOOD / RIFFELRASPELN / ФИГУРНЫЕ РАШПИЛИ	51
JEHLOVÉ RAŠPLE NEEDLE RASPS / NADELRASPELN / ФИГУРНЫЕ РАШПИЛИ	53
OCÍLKY NA NOŽE BUTCHER STEELS / FLEISCHER STÄHLE / ПРИСПОСОБЛЕНИЯ ДЛЯ ЗАТОЧКИ НОЖЕЙ	54
SPECIALITY & CHROM SPECIALS / SONDERFERTIGUNG / СПЕЦИАЛЬНЫЕ ПРОДУКТЫ	55
DRŽADLA HANDLES / GRIFFE / РУЧКИ	56
LASER LASER / LASER / ЛАЗЕР	57
OBRÁBĚNÍ DÍLCŮ NA ZAKÁZKU CUSTOMIZED MACHINING / AUFTRAGSBEARBEITUNG / Обработка деталей по заказу	58

POPIS PILNÍKU

Description of the File

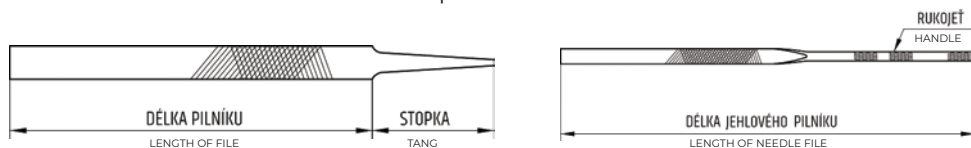

CZ

Průřezy uvedené v tabulkách jsou měřeny přes sek a mohou se měnit v závislosti na hrubosti seku. U kónických pilníků se průřez měří v nejvyšším a nejšířším místě.

EN

The Cross-sections listed in tables below are measured over the cut and may vary depending on roughness of the cut. For conical files, the cross-section is measured at the highest and widest point.

DE

Die in den Tabellen aufgeführten Querschnitte werden über den Hieb gemessen und können je nach Rauheit des Hiebs variieren. Bei kónischen Feilen wird der Querschnitt am höchsten und breitesten Punkt gemessen.

RU

Сечения, указанные в таблицах, измеряются через насечку и могут изменяться в зависимости от шероховатости насечки. Для конических напильников поперечное сечение измеряется в самой высокой и самой широкой точке.

Délka pilníku, rašple File length, rasp length Feilenlänge, Raspellänge Длина напильников и рашпелей	Označení seku Cut specification / Hiebezeichnung / Обозначение насечки		
	1	2	3
mm	Počet zubů na cm Number of teeth per cm / Hiebzahl pro cm / Число насечек на 1 см		
100	17	22	28
150	13	18	22
200	10	14	18
250	9	12	16
300	8	11	14
350	7	10	13
400	7	9	12

DÍLENSKÉ A KLÍČOVÉ PILNÍKY

File Cut - Engineer's and Key Files

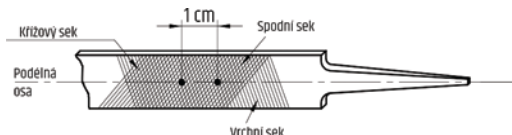
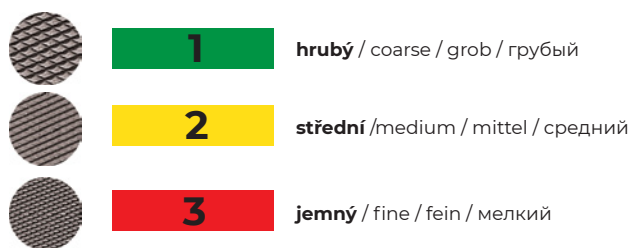

Délka pilníku, rašple File length, rasp length Feilenlänge, Raspellänge Длина напильников и рашпелей	Označení seku Cut specification / Hiebezeichnung / Обозначение насечки		
	2		
	Počet zubů na cm Number of teeth per cm / Hiebzahl pro cm / Число насечек на 1 см		
	normální	úzký	plochý
mm	PIV, PIZ	PIN	
125	-	22	-
150	17	20	24
175	16	-	-
200	15	17	20
250	14	16	18
300	-	-	16

PILNÍKY NA PILY

Saw files

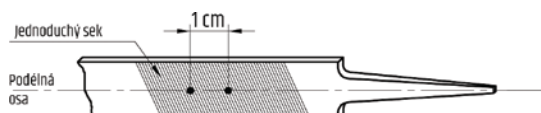

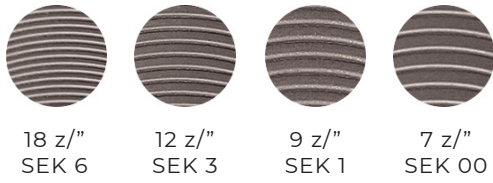

FRÉZOVANÉ PILNÍKY A PLÁTKY S KRUHOVÝM ZUBEM
Milled Files - Curved Tooth

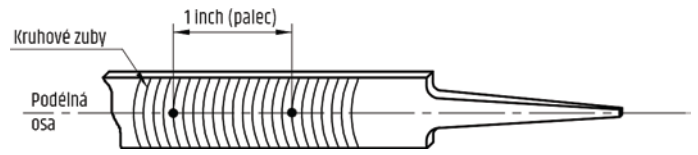

FRÉZOVANÉ PILNÍKY S PŘÍMÝM ZUBEM
Milled Files - Straight Tooth

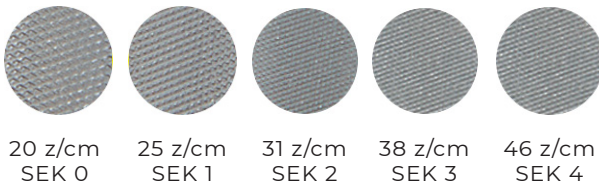
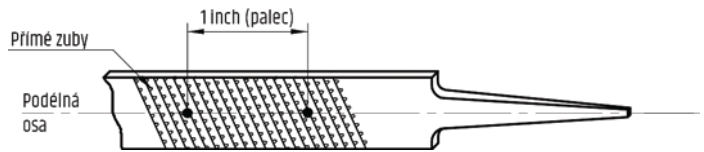

JEHLOVÉ PILNÍKY
Needle files

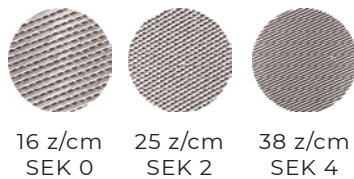
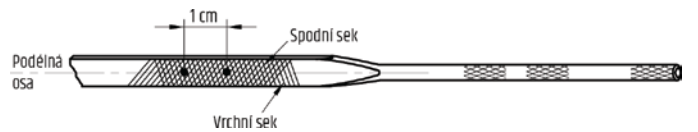

PRECIZNÍ PILNÍKY
Precision File Cut

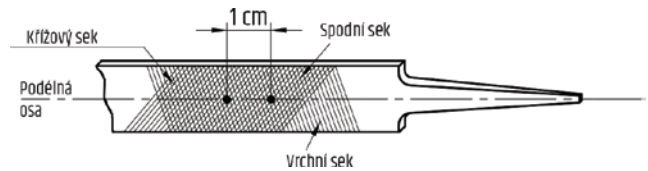

SILNÉ
Die makers' rifflers

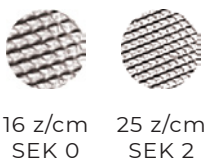

SLABÉ
Die sinkers' rifflers



RYTECKÉ PILNÍKY
Die sinkers' riffler

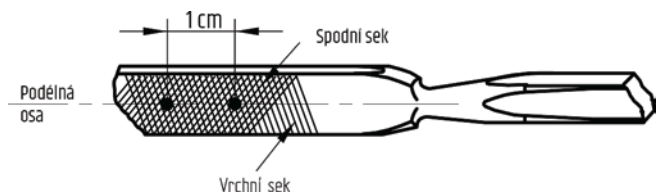

Všechny délky pilníků All file lengths Alle Feilenlängen Все длины напильник	Označení seku Cut specification / Hiebezeichnung / Обозначение насечки	
	1	2
	Počet zubů na cm Number of teeth per cm / Hiebzahl pro cm / Число насечек на 1 см	
SKI - SKIP - SKIPS	11	14
	Počet zubů na palec Number of teeth per inch / Hiebzahl pro Zoll / Число насечек на дюйм	
PFL	9	-

SKI PILNÍKY

File Cut - Ski Files



1

hrubý / coarse / grob / грубый



2

střední / medium / mittel / средний

Všechny délky pilníků All file lengths Alle Feilenlängen Все длины напильник	Označení seku Cut specification / Hiebezeichnung / Обозначение насечки			
	0	00	000	0000
	Počet zubů na cm Number of teeth per cm / Hiebzahl pro cm / Число насечек на 1 см			
	20	16	12	9

STROJNÍ PILNÍKY

File Cut - Machine Files

TECHNICKÉ TERMÍNY - TECHNICAL TERMS - FACHBEGRIFFE - ТЕХНИЧЕСКИЕ УСЛОВИЯ

Délka pilníku - Length of file - Feilenlänge - Длина напильника

Stopka - Tang – Angel - Хвостовик

Délka jehlového pilníku - Length of Needle File - Nadelfeilenlänge - Длина надфиля

Rukojeť - Handle - Handgriff - Рукоятка

Podélná osa - Linear Axis - Längsachse - Продольная ось

Spodní sek - Bottom Cut - Unterhieb - Нижняя насечка

Vrchní sek - Upper Cut - Oberhieb - Верхняя насечка

Jednoduchý sek - Single Cut - Einfachhieb - Одинарная насечка

Křížový sek - Cross Cut - Kreuzhieb - Перекрёстная (двойная) насечка

Rašplový sek - Rasp Cut - Raspelhieb - Рашпильная насечка

Kruhové zuby - Curved Teeth - Radial verzahnt – Зубья дуговой насечки

Přímé zuby - Straight Teeth - Schräg verzahnt – Зубья точечной насечки

Délka pilníku, rašple File length, rasp length Feilenlänge, Raspellänge Длина напильников и рашпелей	Označení seku Cut specification / Hiebzeichnung / Обозначение насечки		
	1	2	3
mm	Počet zubů na cm ² Number of teeth per cm ² / Hiebzahl pro cm ² / Число насечек на 1 см ²		
100	-	30	38
150	14	20	28
200	10	16	22
250	8	12	18
300	6	10	14

STROJNĚ SEKANÉ RAŠPLE
Rasp Cut

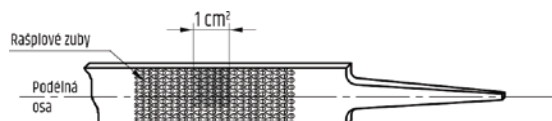
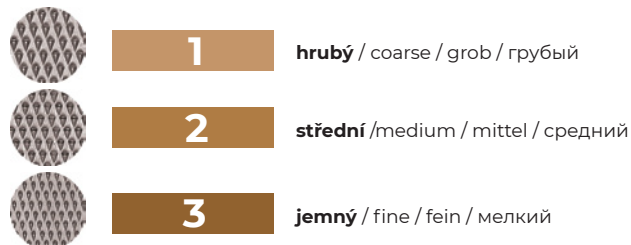

RUČNĚ SEKANÉ RAŠPLE
Rasp Cut - Hand

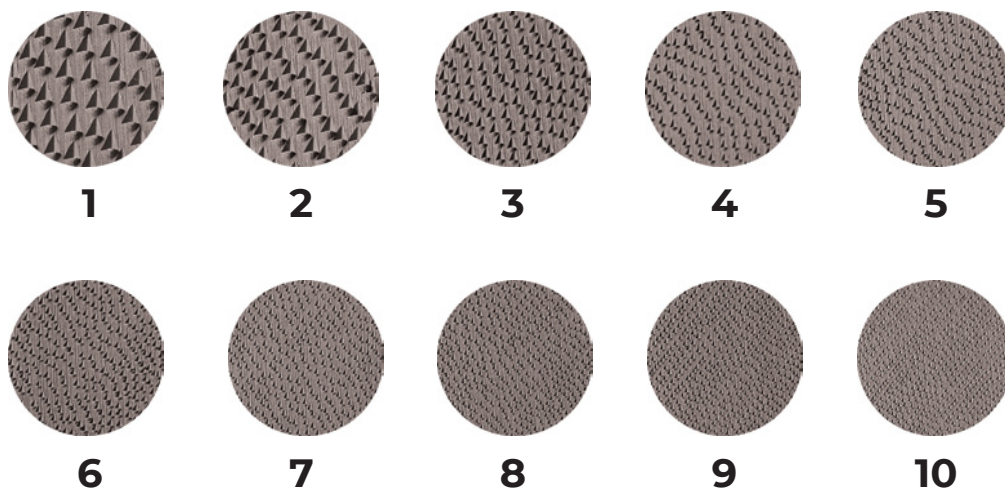

Délka pilníku, rašple File length, rasp length Feilenlänge, Raspellänge Длина напильников и рашпелей	Označení seku Cut specification / Hiebzeichnung / Обозначение насечки									
	1	2	3	4	5	6	7	8	9	10
mm	Počet zubů na cm ² Number of teeth per cm ² / Hiebzahl pro cm ² / Число насечек на 1 см ²									
100	-	-	-	40	50	60	70	80	90	100
150	-	-	30	40	50	60	70	80	90	100
200	-	20	30	40	50	60	70	80	90	100
250	10	20	30	40	50	60	70	80	90	100
300	10	20	30	40	50	60	70	80	90	100



CZ

Nejuniverzálnější typ pilníku. Používají se pro běžné potřeby pilování v dílnách, výrobě i domácnostech. Tyto pilníky mají křížový sek. Tvar a hrubost daného pilníku závisí na typu práce a požadovaném výsledku. Obecně platí, že čím hrubší sek, tím větší úběr materiálu. Pro hladší povrch by se měl zvolit pilník s jemnějším sekem. Dodáváme s klasickým i ergonomickým držadlem.

EN

The most universal type of file. Use for routine filing work in workshops, in manufacturing and in households. These files have a cross cut. The shape and coarseness of a given file depends on the type of work and the desired result. In general, the coarser the cut, the greater the amount of material removed. A file with a finer cut should be chosen for a smoother surface. We supply our files with a classic or ergonomic handle.

DE

Der universellste Feilentyp. Sie werden für allgemeine Feilbedürfnisse in Werkstätten, in der Produktion und in Haushalten verwendet. Diese Feilen haben einen Querhieb. Die Form und Rauheit der jeweiligen Feile hängen von der Art der Arbeit und dem gewünschten Ergebnis ab. Im Allgemeinen ist der Materialabtrag umso größer, je gröber der Hieb ist. Für eine glattere Oberfläche sollte eine Feile mit einem feineren Hieb gewählt werden. Wir liefern sie mit einem klassischen und ergonomischen Griff.

RU

Самый универсальный тип напильников. Они используются для общих работ по опиливанию поверхности в мастерских, на производстве и в быту. Эти напильники имеют перекрестную насечку. Форма и шероховатость данных напильников зависят от типа работ и желаемого результата. В общем действует правило, чем грубее насечка, тем больше материала опиливается. Для более гладкой поверхности мы рекомендуем использовать напильники с более мелкой насечкой. Мы поставляем их с классической и эргономичной ручкой.

Typ Type Тип	Tvar Shape Form Форма	Délka Length Länge Длина	Průřez Section Querschnitt Сечение	Hmotnost / ks Weight / pc Gewicht / Stk. Вес / Канзас
--------------------	--------------------------------	-----------------------------------	---	--

PLOCHÝ - lehký HAND THIN FLACHSTUMPF <small>dünne Form</small> ПЛОСКИЙ ТОНКИЙ	PLO	mm	mm	kg
		150	16 x 3,5	90
		200	20 x 3,5	140
		250	25 x 4,5	270
		300	30 x 4,5	350

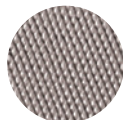

PLOCHÝ HAND FLACHSTUMPF ПЛОСКИЙ	PSO	mm	mm	kg
		100	12 x 3	50
		150	16 x 4	100
		200	20 x 5	200
		250	25 x 6	340
		300	30 x 7	470

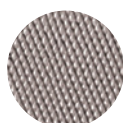

PLOCHOŠPIČATÝ FLAT FLACHSPITZ СУЖАЮЩИЙСЯ	PZA	mm	mm	kg
		100	12 x 3	50
		150	16 x 4	100
		200	20 x 5	180
		250	25 x 6	330
		300	30 x 7	440

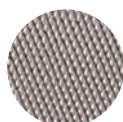

ČTYŘHRANNÝ SQUARE VIERKANT КВАДРАТНЫЙ	PZC	mm	mm	kg
		100	4	30
		150	6	70
		200	8	130
		250	10	220
		300	12	330

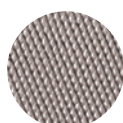

TŘÍHRANNÝ THREESQUARE DREIKANT ТРЕУГОЛЬНЫЙ	PZT	mm	mm	kg
		100	8	50
		150	10	80
		200	15	200
		250	17,5	350
		300	20	400

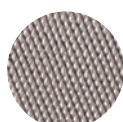

Sek / Cut / Hieb / Насечка

1	2	3
Objednáací číslo / Code / Bestell - Nr. / Артикул		
286 211 10 1515	286 211 10 1525	286 211 10 1535
286 211 10 2015	286 211 10 2025	286 211 10 2035
286 211 10 2515	286 211 10 2525	286 211 10 2535
286 211 10 3015	286 211 10 3025	286 211 10 3035

286 211 21 1015	286 211 21 1025	286 211 21 1035
286 211 21 1515	286 211 21 1525	286 211 21 1535
286 211 21 2015	286 211 21 2025	286 211 21 2035
286 211 21 2515	286 211 21 2525	286 211 21 2535
286 211 21 3015	286 211 21 3025	286 211 21 3035

286 211 27 1015	286 211 27 1025	286 211 27 1035
286 211 27 1515	286 211 27 1525	286 211 27 1535
286 211 27 2015	286 211 27 2025	286 211 27 2035
286 211 27 2515	286 211 27 2525	286 211 27 2535
286 211 27 3015	286 211 27 3025	286 211 27 3035

286 211 45 1015	286 211 45 1025	286 211 45 1035
286 211 45 1515	286 211 45 1525	286 211 45 1535
286 211 45 2015	286 211 45 2025	286 211 45 2035
286 211 45 2515	286 211 45 2525	286 211 45 2535
286 211 45 3015	286 211 45 3025	286 211 45 3035

286 211 50 1015	286 211 50 1025	286 211 50 1035
286 211 50 1515	286 211 50 1525	286 211 50 1535
286 211 50 2015	286 211 50 2025	286 211 50 2035
286 211 50 2515	286 211 50 2525	286 211 50 2535
286 211 50 3015	286 211 50 3025	286 211 50 3035

Typ Type Тип	Tvar Shape Form Форма	Délka Length Länge Длина	Průřez Section Querschnitt Сечение	Hmotnost / ks Weight / pc Gewicht / Stk. Вес / Канзас
		mm	mm	г/шт
KRUHOVÝ ROUND RUND КРУГЛЫЙ	PZK 	100	4	40
		150	6	60
		200	8	110
		250	10	180
		300	12	290



Typ	Tvar	Délka	Průřez	Hmotnost / ks
		mm	mm	г/шт
ÚSEČOVÝ HALFROUND HALBRUND ПОЛУКРУГЛЫЙ	PZP 	100	12 x 3	40
		150	16 x 5	100
		200	20 x 6	180
		250	25 x 8	300
		300	28 x 9	470

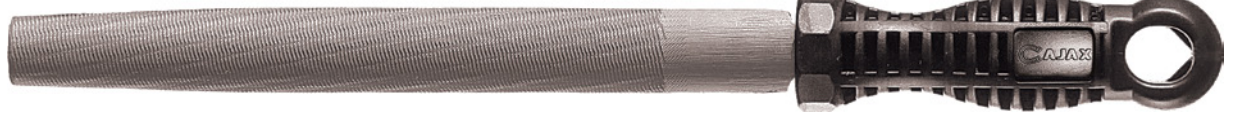

Typ	Tvar	Délka	Průřez	Hmotnost / ks
		mm	mm	г/шт
NOŽOVÝ KNIFE MESSER НОЖЕВОЙ	PZN 	150	16 x 4	100
		200	20 x 5	160
		250	25 x 6,5	320

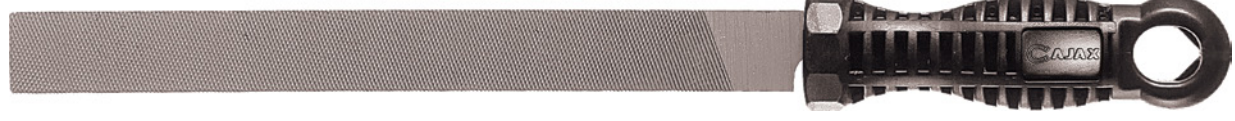
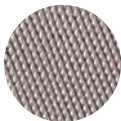

Sek / Cut / Hieb / Насечка		
1	2	3
Objednací číslo / Code / Bestell - Nr. / Артикул		
286 211 60 1015	286 211 60 1025	286 211 60 1035
286 211 60 1515	286 211 60 1525	286 211 60 1535
286 211 60 2015	286 211 60 2025	286 211 60 2035
286 211 60 2515	286 211 60 2525	286 211 60 2535
286 211 60 3015	286 211 60 3025	286 211 60 3035

286 211 63 1015	286 211 63 1025	286 211 63 1035
286 211 63 1515	286 211 63 1525	286 211 63 1535
286 211 63 2015	286 211 63 2025	286 211 63 2035
286 211 63 2515	286 211 63 2525	286 211 63 2535
286 211 63 3015	286 211 63 3025	286 211 63 3035

286 211 72 1515	286 211 72 1525	286 211 72 1535
286 211 72 2015	286 211 72 2025	286 211 72 2035
286 211 72 2515	286 211 72 2525	286 211 72 2535

CZ

Délky 350 mm a 400 mm najdete v sekci DÍLENSKÉ PILNÍKY S ERGONOMICKÝM DRŽADLEM.

EN

Lengths of 350 mm and 400 mm can be found in the section ENGINEER'S FILES WITH AN ERGONOMIC HANDLE.

DE

Längen von 350 mm und 400 mm finden Sie im Abschnitt WERKSTATTFEILEN MIT ERGONOMISCHEM GRIFF.

RU

Напильники длиной 350 мм и 400 мм вы можете найти в разделе «НАПИЛЬНИКИ ДЛЯ МАСТЕРСКИХ С ЭРГОНОМИЧНОЙ РУЧКОЙ».

Délka Length Länge Длина	Hmotnost / ks Weight / pc Gewicht / Stk. Вес / Канзас	Sek Cut / Hieb / Насечка
mm	г/шт	2
150	400	286 211 92 1525
200	850	286 211 92 2025

Délka Length Länge Длина	Hmotnost / ks Weight / pc Gewicht / Stk. Вес / Канзас	Sek Cut / Hieb / Насечка
mm	г/шт	2
150	280	286 211 93 1525
200	530	286 211 93 2025
250	850	286 211 93 2525

Délka Length Länge Длина	Hmotnost / ks Weight / pc Gewicht / Stk. Вес / Канзас	Sek Cut / Hieb / Насечка
mm	г/шт	2
100	270	286 211 94 1025

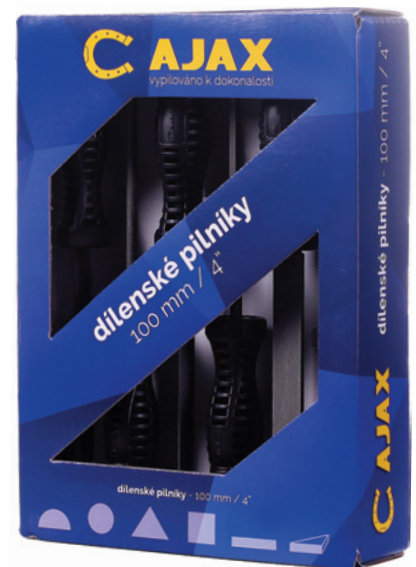
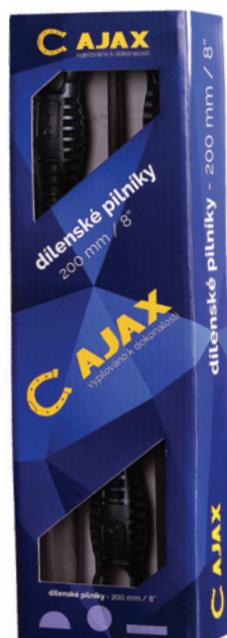
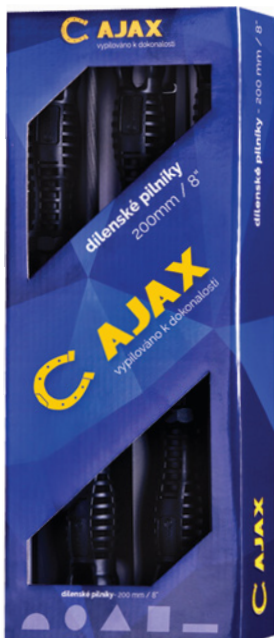

Typ Type Typ Тип	Tvar Shape Form Форма	Délka Length Länge Длина	Průřez Section Querschnitt Сечение	Hmotnost / ks Weight / pc Gewicht / Stk. Вес / Канзас
---------------------------	--------------------------------	-----------------------------------	---	--

PLOCHÝ - lehký HAND THIN FLACHSTUMPF <small>dünne Form</small> ПЛОСКИЙ ТОНКИЙ	PLO-E	mm	mm	г/шт
		150	16 x 3,5	90
		200	20 x 3,5	140
		250	25 x 4,5	270
		300	30 x 4,5	350

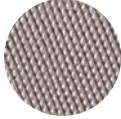

PLOCHÝ HAND FLACHSTUMPF ПЛОСКИЙ	PSO-E	mm	mm	mm
		150	16 x 4	100
		200	20 x 5	200
		250	25 x 6	340
		300	30 x 7	470
		350	36 x 8	800
		400	90 x 9	1000



PLOCHOŠPÍČATÝ FLAT FLACHSPITZ СУЖАЮЩИЙСЯ	PZA-E	mm	mm	mm
		150	16 x 4	100
		200	20 x 5	180
		250	25 x 6	330
		300	30 x 7	440

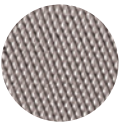

ČTYŘHRANNÝ SQUARE VIERKANT КВАДРАТНЫЙ	PZC-E	mm	mm	mm
		150	6	70
		200	8	130
		250	10	220
		300	12	330
		350	14	570

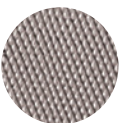

TŘÍHRANNÝ THREESQUARE DREIKANT ТРЕУГОЛЬНЫЙ	PZT-E	mm	mm	mm
		150	10	80
		200	15	200
		250	17,5	350
		300	20	400
		350	22	640

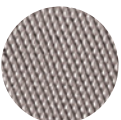

Sek / Cut / Hieb / Насечка

1	2	3
Objednací číslo / Code / Bestell - Nr. / Артикул		
286 203 10 1515	286 203 10 1525	286 203 10 1535
286 203 10 2015	286 203 10 2025	286 203 10 2035
286 203 10 2515	286 203 10 2525	286 203 10 2535
286 203 10 3015	286 203 10 3025	286 203 10 3035

286 203 21 1515	286 203 21 1525	286 203 21 1535
286 203 21 2015	286 203 21 2025	286 203 21 2035
286 203 21 2515	286 203 21 2525	286 203 21 2535
286 203 21 3015	286 203 21 3025	286 203 21 3035
286 203 21 3515	286 203 21 3525	286 203 21 3535
286 203 21 4015	286 203 21 4025	286 203 21 4035

286 203 27 1515	286 203 27 1525	286 203 27 1535
286 203 27 2015	286 203 27 2025	286 203 27 2035
286 203 27 2515	286 203 27 2525	286 203 27 2535
286 203 27 3015	286 203 27 3025	286 203 27 3035

286 203 45 1515	286 203 45 1525	286 203 45 1535
286 203 45 2015	286 203 45 2025	286 203 45 2035
286 203 45 2515	286 203 45 2525	286 203 45 2535
286 203 45 3015	286 203 45 3025	286 203 45 3035
286 203 45 3515	286 203 45 3525	286 203 45 3535

286 203 50 1515	286 203 50 1525	286 203 50 1535
286 203 50 2015	286 203 50 2025	286 203 50 2035
286 203 50 2515	286 203 50 2525	286 203 50 2535
286 203 50 3015	286 203 50 3025	286 203 50 3035
286 203 50 3515	286 203 50 3525	286 203 50 3535

Typ Type Тип	Tvar Shape Form Форма	Délka Length Länge Длина	Průřez Section Querschnitt Сечение	Hmotnost / ks Weight / pc Gewicht / Stk. Вес / Канзас
--------------------	--------------------------------	-----------------------------------	---	--

		mm	mm	г/шт
KRUHOVÝ ROUND RUND КРУГЛЫЙ	PZK-E 	150	6	60
		200	8	110
		250	10	180
		300	12	290
		350	14	540

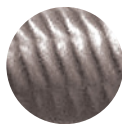

		mm	mm	mm	g/pc
ÚSEČOVÝ HALFROUND HALBRUND ПОЛУКРУГЛЫЙ	PZP-E 	150	16 x 5	100	
		200	20 x 6	180	
		250	25 x 8	300	
		300	28 x 9	470	
		350	32 x 10	720	



Sek / Cut / Hieb / Насечка		
1	2	3

Objednací číslo / Code / Bestell - Nr. / Артикул

286 203 60 1515	286 203 60 1525	286 203 60 1535
286 203 60 2015	286 203 60 2025	286 203 60 2035
286 203 60 2515	286 203 60 2525	286 203 60 2535
286 203 60 3015	286 203 60 3025	286 203 60 3035
286 203 60 3515	286 203 60 3525	286 203 60 3535

286 203 63 1515	286 203 63 1525	286 203 63 1535
286 203 63 2015	286 203 63 2025	286 203 63 2035
286 203 63 2515	286 203 63 2525	286 203 63 2535
286 203 63 3015	286 203 63 3025	286 203 63 3035
286 203 63 3515	286 203 63 3525	286 203 63 3535

Délka Length Länge Длина	Hmotnost / ks Weight / pc Gewicht / Stk. Вес / Канзас	Sek Cut / Hieb / Насечка
mm	г/шт	2
150	400	286 203 92 1525
200	850	286 203 92 2025

Délka Length Länge Длина	Hmotnost / ks Weight / pc Gewicht / Stk. Вес / Канзас	Sek Cut / Hieb / Насечка
mm	г/шт	2
150	280	286 203 93 1525
200	530	286 203 93 2025
250	850	286 203 93 2525



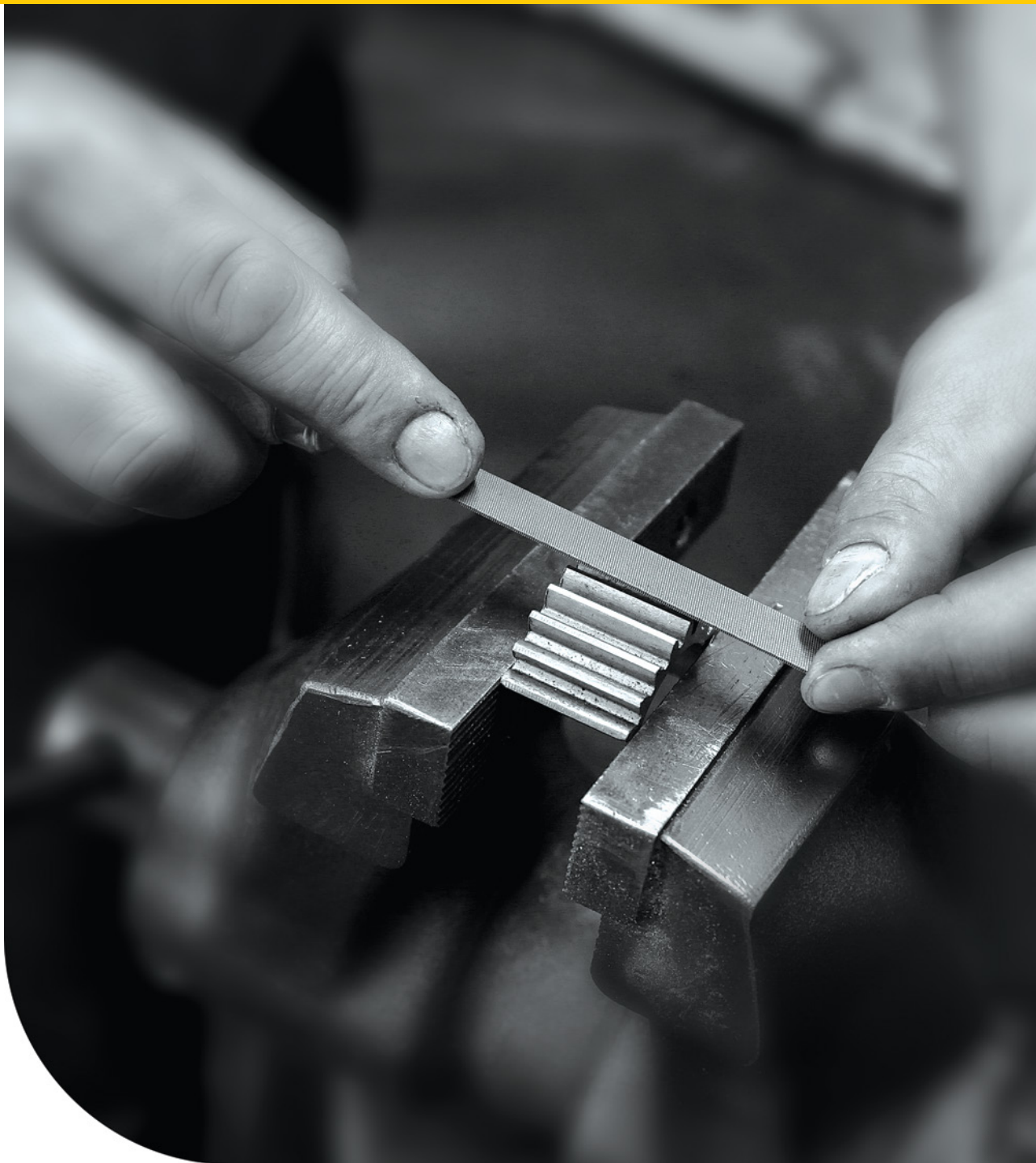

CZ

Klíčové pilníky se používají převážně pro jemnější a dokončovací zámečnické práce. Tyto malé pilníky jsou vhodné na lehké a velmi jemné pilování, a to především při výrobě nástrojů a forem. Mají křížový sek.

EN







Key files are used primarily for finer and finishing locksmithing work. These small files are suitable for light and very fine filing, particularly during the production of tools and moulds. They have a cross cut.

DE

Schlüsselfeilen werden hauptsächlich für feinere und abschließende Schlosserarbeiten verwendet. Diese kleinen Feilen eignen sich zum leichten und sehr feinen Feilen, insbesondere bei der Herstellung von Werkzeugen und Formen. Sie haben einen Kreuzhieb.

RU

Напильники для ключей используются для самой точной обработки материалов, а также окончательного опилования при проведении слесарных работ. Эти небольшие напильники рекомендуются для легкой и очень гладкой зачистки, особенно при производстве инструментов и форм. Имеют перекрестную насечку.

Typ Type Typ Тип	Tvar Shape Form Форма	Délka Length Länge Длина	Průřez Section Querschnitt Сечение	Hmotnost / ks Weight / pc Gewicht / Stk. Вес / Канзас
		mm	mm	г/шт
PLOCHÝ HAND FLACHSTUMPF ПЛОСКИЙ	PSO-K 	100	10 x 1,2	40
PLOCHOŠPIČATÝ FLAT FLACHSPITZ СУЖАЮЩИЙСЯ	PZA-K 	100	10 x 1,2	40
ČTYŘHRANNÝ SQUARE VIERKANT КВАДРАТНЫЙ	PZC-K 	100	3	40
TŘÍHRANNÝ THREESQUARE DREIKANT ТРЕУГОЛЬНЫЙ	PZT-K 	100	5	40
KRUHOVÝ ROUND RUND КРУГЛЫЙ	PZK-K 	100	3	40
ÚSEČOVÝ HALFROUND HALBRUND ПОЛУКРУПНЫЙ	PZP-K 	100	9,5 x 3	40

Sek / Cut / Hieb / Насечка

2

Objednací číslo / Code / Bestell - Nr. / Артикул

286 202 21 1025



286 202 27 1025



286 202 45 1025



286 202 50 1025



286 202 60 1025



286 202 63 1025

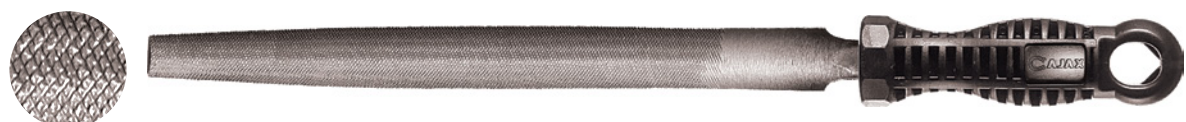

Délka Length Länge Длина	Hmotnost / ks Weight / pc Gewicht / Stk. Вес / Канзас	Sek Cut / Hieb / Насечка
mm	г/шт	2
100	180	Objednací číslo Code / Bestell - Nr. / Артикул 286 202 92 1025

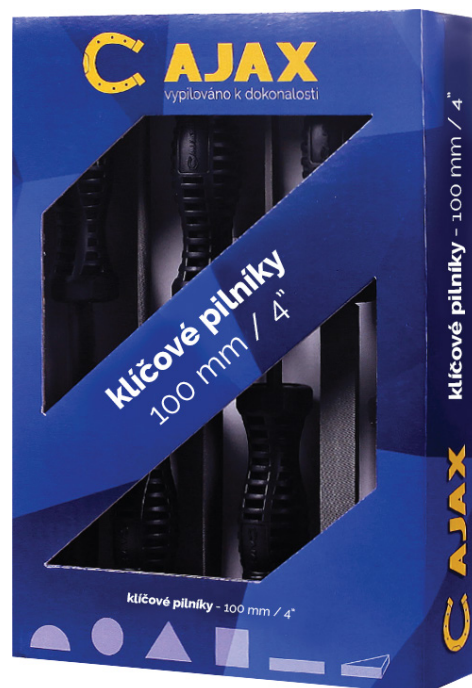



CZ

Používají se na opracování oceli, měkkých kovů, plastů a plechů. Frézované pilníky lze použít i na práci se dřevem. Vyrábíme je v následujících délkách:
Frézované pilníky: 100 – 350 mm
Frézované plátky: 20 – 400 mm
Oba typy lze vyrobit v hrubostech 7 – 18 zubů na palec.

EN

Used for machining steel, soft metals, plastics and sheet metal. Milled files can also be used for woodworking. We produce them in the following lengths:
Milled files: 100 – 350 mm
Milled blades: 20 – 400 mm
Both types can be produced with 7 – 18 teeth per inch.

DE

Sie werden zur Bearbeitung von Stahl, Weichmetallen, Kunststoffen und Blechen eingesetzt. Gefräste Feilen können auch bei Holzarbeiten verwendet werden. Wir produzieren sie in folgenden Längen:
Gefräste Feilen: 100 – 350 mm
Gefräste Blätter: 20 – 400 mm
Beide Typen können in Rauheiten von 7 bis 18 Zähnen pro Zoll hergestellt werden.

RU

Они используются для обработки стали, мягких металлов, пластмасс и жести. Напильники с фрезерованными зубьями также можно использовать для работы с деревом. Мы производим их следующей длиной:
Напильники с фрезерованными зубьями: 100 – 350 мм
Пластинки с фрезерованными зубьями: 20 – 400 мм
Оба типа могут быть произведены с шероховатостью 7 – 18 зубьев на дюйм.

Typ Type Typ Тип	Tvar Shape Form Форма	Délka Length Länge Длина	Průřez Section Querschnitt Сечение	Hmotnost / ks Weight / pc Gewicht / Stk. Вес / Канзас
---------------------------	--------------------------------	-----------------------------------	---	--

	PFO k.z.	mm	mm	kg
PLOCHÝ - s kruhovými zuby HAND - curved tooth FLACHSTUMPF - radial verzahnt ПЛОСКИЙ - с круговой насечкой		250	25 x 6	250
		300	30 x 7	430
		350	36 x 8	740



	PFO p.z.	mm	mm	kg
PLOCHÝ - s přímými zuby HAND - straight tooth FLACHSTUMPF - schräg verzahnt ПЛОСКИЙ - с прямой насечкой		250	25 x 6	250
		300	30 x 7	430
		350	36 x 8	740



	PFCp	mm	mm	kg
PILNÍK NA BRZDOVÉ TŘMENY BRAKE CALIPER FILE BREMSSATTEL DATEI ФАЙЛ ТОРМОЗНОГО СУПОРТА		150	10	120

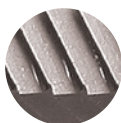

	PFKs	mm	mm	kg
FRÉZOVANÝ PLÁTEK - s kruhovými zuby CAR BODY FILE BLADE - curved tooth KAROSSERIEFEILENBLATT - radial verzahnt ПЛОСКИЙ - для рубанка		350	35 x 5	300

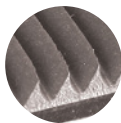

	PFK	mm	mm	kg
FRÉZOVANÝ PLÁTEK - s kruhovými zuby CAR BODY FILE BLADE - curved tooth KAROSSERIEFEILENBLATT - radial verzahnt ПЛОСКИЙ - для рубанка		350	35 x 5	300

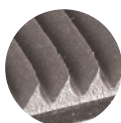

Sek / Cut / Hieb / Насечка

1

3

Objednáací číslo / Code / Bestell - Nr. / Артикул

286 211 36 2515	286 211 36 2535
286 211 36 3015	286 211 36 3035
286 211 36 3515	286 211 36 3535

286 211 37 2515	286 211 37 2535
286 211 37 3015	286 211 37 3035
286 211 37 3515	286 211 37 3535

286 211 40 1590

286 211 39 3511 286 211 39 3531

286 211 39 3513 286 211 39 3533



CZ

Používají se k upnutí do pneumatických a elektrických nástrojů (např. vrtaček, škrabáků, pilovacích strojů atd.). Strojní pilníky slouží k odjehlování a úběru materiálu. Mají křížový sek.

EN

These files are designed to be clamped to pneumatic and electric tools (e.g. drills, scrapers, filing machines, etc.). Machine files are used for deburring and removing material. They have a cross cut.

DE

Sie werden zur Befestigung in Druckluft- und Elektrowerkzeugen (z. B. Bohrern, Schabern, Sägemaschinen usw.) eingesetzt. Maschinenfeilen werden zum Entgraten und Abtragen von Material verwendet. Sie haben einen Kreuzziehb.

RU

Они используются для зажима в пневматических и электрических инструментах (например, дрелях, скребках, машинах для шлифования и т. д.). Насадные напильники используются для удаления заусенцев и опилования материала. Имеют перекрестную насечку.

Typ Type Тип	Tvar Shape Form Форма	Délka Length Länge Длина	Průřez Section Querschnitt Сечение	Stopka Tang Angel Хвостовик
--------------------	--------------------------------	-----------------------------------	---	--------------------------------------

PLOCHÝ ROVNÝ HAND STRAIGHT FLACHSTUMPF GERADE ПЛОСКИЙ ПРЯМОЙ	XPJA_r 	90	6,4 x 2,4	4 x 20
--	--	----	-----------	--------

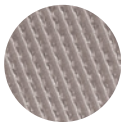

PLOCHÝ OHNUTÝ HAND BENT FLACHSTUMPF GEBOGEN ПЛОСКИЙ ИЗОГНУТЫЙ	XPJA_o 	90	6,4 x 2,4	4 x 20
---	--	----	-----------	--------

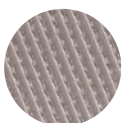

ÚSEČOVÝ CYLINDRICKÝ HALFROUND CYLINDRICAL HALBRUND ZYLINDRISCH РОЛУКРУГЛЫЙ ЦИЛИНДРИЧЕСКИЙ	XPJA_c 	90	6,5 x 3	4 x 20
---	---	----	---------	--------

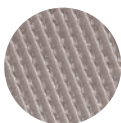

ČTYŘHRANNÝ SQUARE VIERKANT КВАДРАТНЫЙ	XPJA_s 	135	7,3	6 x 20
---	--	-----	-----	--------

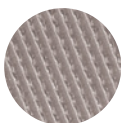

PLOCHÝ HAND FLACHSTUMPF ПЛОСКИЙ	XPJA_s 	90	10 x 3	4 x 20
		110	15 x 3	6 x 20

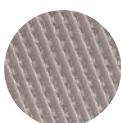

Sek / Cut / Hieb / Насечка
000
00
0

Objednáací číslo / Code / Bestell - Nr. / Артикул

286 213 80 9030	286 213 80 9020	286 213 80 9010
------------------------	------------------------	------------------------



286 213 80 0930	286 213 80 0920	286 213 80 0910
------------------------	------------------------	------------------------



286 213 85 9001	286 213 85 9000	286 213 85 9002
------------------------	------------------------	------------------------



286 211 34 1350



286 201 10 9000
286 211 34 1100



Typ Type Тип	Tvar Shape Форма	Délka Length Лänge Длина	Průřez Section Querschnitt Сечение	Stopka Tang Angel Хвостовик	Sek / Cut / Hieb / Насечка					
		mm	mm	□—	0000	000	00	0	1	2

Objednací číslo / Code / Bestell - Nr. / Артикул

ÚSEČOVÝ HALFROUND HALBRUND РОЛУКРУГЛЫЙ	XPÚs 	90	10 x 3	4 x 20	286 211 34 2186					
		130	12 x 4,4	6 x 20	286 211 34 1305					

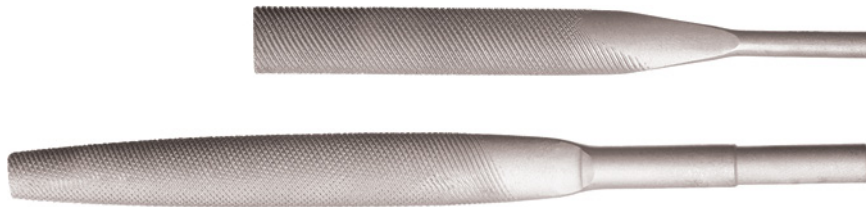
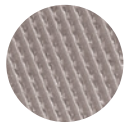

KULATÝ ROUND RUND КРУГЛЫЙ	XPКs 	150	6	6 x 20	286 211 60 1505					
---	--	-----	---	--------	-----------------	--	--	--	--	--

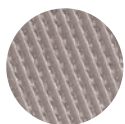

KULATÝ ROUND RUND КРУГЛЫЙ	XPJK 	95	3,2	3 x 25	-	-	-	286 213 84 9501	286 213 84 9502	286 213 84 9503
---	--	----	-----	--------	---	---	---	-----------------	-----------------	-----------------

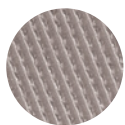

KULATÝ CYLINDRICKÝ ROUND CYLINDRICAL RUND ZYLINDRISCH КРУГЛЫЙ ЦИЛИНДРИЧЕСКИЙ	XPJKc 	90	4,5	4 x 20	-	286 213 84 9004	286 213 84 9003	286 213 84 9000	286 213 84 9001	286 213 84 9002
--	---	----	-----	--------	---	-----------------	-----------------	-----------------	-----------------	-----------------

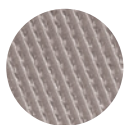

KULATÝ CYLINDRICKÝ OHNUTÝ ROUND CYLINDRICAL BENT RUND ZYLINDRISCH GEBOGEN КРУГЛЫЙ ЦИЛИНДРИЧЕСКИЙ ИЗОГНУТЫЙ	XPJKco 	90	3,7	3,5 x 20	-	286 213 84 9005	286 213 84 9006	286 213 84 9007	286 213 84 9008	286 213 84 9009
---	--	----	-----	----------	---	-----------------	-----------------	-----------------	-----------------	-----------------

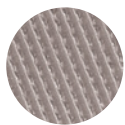

**CZ**

Precizní ruční nástroje k jednoduché opravě a čištění vnitřních i vnějších závitů. Nejsou určeny k vytváření závitů. Vyrábíme v několika variantách dle druhu závitů.

EN

Precise hand-operated tools for easily repairing and cleaning internal and external threads. They are not designed for creating threads. We produce them in several variants depending on the type of thread.

DE

Präzise Handwerkzeuge zur einfachen Reparatur und Reinigung von Innen- und Außengewinden. Sie sind nicht zum Erstellen von Gewinden vorgesehen. Wir produzieren sie in verschiedenen Varianten je nach Gewindetyp.

RU

Точные ручные инструменты для проведения простого ремонта и очистки внутренней и наружной резьбы. Они не предназначены для нарезки резьбы. Мы производим их в нескольких вариантах в зависимости от видов резьбы.

Typ Type Typ Тип	Délka Length Länge Длина	Průřez Section Querschnitt Сечение	Hmotnost / ks Weight / pc Gewicht / Stk. Вес / Канзас	Objednáací číslo Code / Bestell - Nr. / Артикул	Stoupání závitu /Steigung / Шаг m/" m/"						
	mm	mm	кг/шт								

ISO (metrický)	230	10	120	286 211 70 2310	80	100	125	150	175	200	250	300
----------------	-----	----	-----	-----------------	----	-----	-----	-----	-----	-----	-----	-----



UNF / UNC	230	10	120	286 211 70 2330	11	12	13	14	16	18	20	24
-----------	-----	----	-----	-----------------	----	----	----	----	----	----	----	----

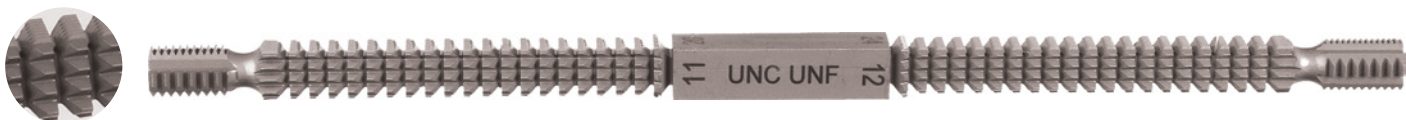

WW (WITHWORTH)	230	10	120	286 211 70 2340	10	11	12	14	16	18	20	24
----------------	-----	----	-----	-----------------	----	----	----	----	----	----	----	----



G	230	10	120	286 211 70 2320	11	14	19	28
---	-----	----	-----	-----------------	----	----	----	----

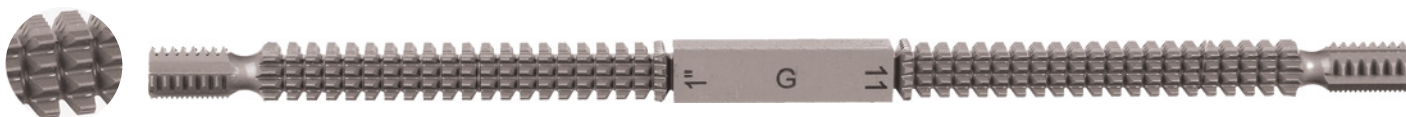

SCAN & PLAY



ISO	UNC-UNF	WW	G
stoupání závitu (mm) thread pitch (mm)	počet závitů na 1" number of threads per inch	počet závitů na 1" number of threads per inch	počet závitů na 1" number of threads per inch
0,80	24	24	28
1,00	20	20	19
1,25	18	18	14
1,50	16	16	11
1,75	14	14	
2,00	13	12	
2,50	12	11	
3,00	11	10	

Měrka pro zjištění stoupání závitu
i pilník na vnitřní závity
Gauge and file for internal threads

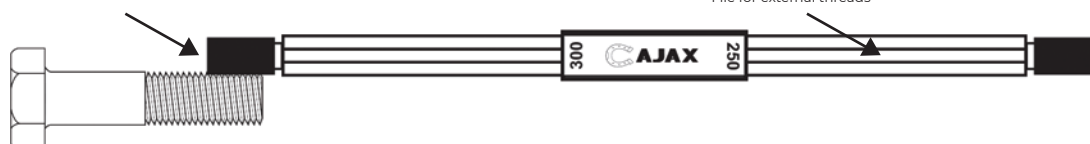

Pilník na vnější závity
File for external threads

Oprava vnitřního závitu
Internal thread repair



Oprava vnějšího závitu
External thread repair

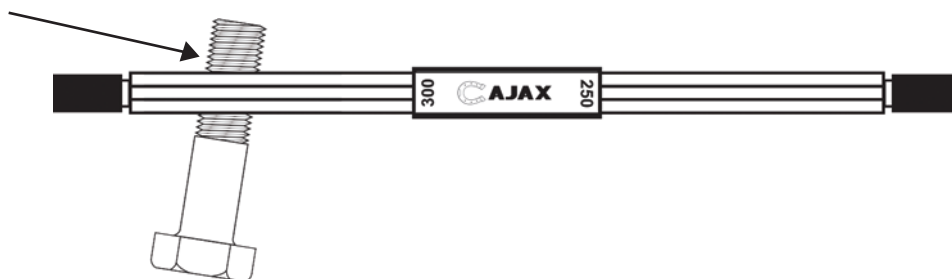

Možnost výroby dalších typů na poptávku.

Production of other types on request.
Produktion anderer Typen auf Anfrage.
Производство других видов по запросу.



CZ

Tyto pilníky používají například zámečníci, rytci, hodináři, výrobci přístrojů a další. Své uplatnění najdou všude, kde je zapotřebí jemného pilování malých ploch. Mají křížový sek. Vyrábíme v délkách 140, 160, 180 a 200 mm.

EN

These files are used, for example, by locksmiths, engravers, watchmakers, instrument manufacturers and many other professions. They are used wherever small surfaces need to be finely filed. They have a cross cut. We produce them in lengths of 140, 160, 180 and 200 mm.

DE

Diese Feilen werden beispielsweise von Schlossern, Graveuren, Uhrmachern, Instrumentenherstellern und anderen verwendet. Sie können überall dort eingesetzt werden, wo kleine Flächen fein gefeilt werden müssen. Sie haben einen Kreuzhieb. Wir produzieren Sie in den Längen 140, 160, 180 a 200 mm.

RU

Эти надфили используются, например, слесарями, гравёрами, часовщиками, производителями инструментов и другими. Их можно использовать везде, где требуется окончательная шлифовка небольших участков. Они имеют перекрестную насечку. Мы производим их длиной 140, 160, 180 и 200 мм.

Typ Type Тип	Tvar Shape Form Форма	Délka Length Länge Длина	Průřez Section Querschnitt Сечение	Hmotnost / ks Weight / pc Gewicht / Stk. Вес / Канзас	Sek / Cut / Hieb / Насечка				
					0	1	2	3	4

					Objednáací číslo / Code / Bestell - Nr. / Артикул				
PLOCHÝ HAND FLACHSTUMPF ПЛОСКИЙ	PJA 	140	5,4 x 1,3	8	286 213 80 1400	286 213 80 1410	286 213 80 1420	286 213 80 1430	286 213 80 1440
		160	5,4 x 1,3	10	286 213 80 1600	286 213 80 1610	286 213 80 1620	286 213 80 1630	286 213 80 1640
		180	6,4 x 1,6	13	286 213 80 1800	286 213 80 1810	286 213 80 1820	286 213 80 1830	286 213 80 1840
		200	7,5 x 1,8	20	286 213 80 2000	286 213 80 2010	286 213 80 2020	286 213 80 2030	286 213 80 2040

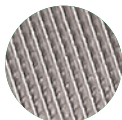

PLOCHOŠPIČATÝ WARDING FLACHSPITZ ПЛОСКИЙ ЗАОСТРЕННЫЙ	PJO 	140	5,4 x 1,3	8	286 213 81 1400	286 213 81 1410	286 213 81 1420	286 213 81 1430	286 213 81 1440
		160	5,4 x 1,3	10	286 213 81 1600	286 213 81 1610	286 213 81 1620	286 213 81 1630	286 213 81 1640
		180	6,4 x 1,6	13	286 213 81 1800	286 213 81 1810	286 213 81 1820	286 213 81 1830	286 213 81 1840
		200	7,5 x 1,8	20	286 213 81 2000	286 213 81 2010	286 213 81 2020	286 213 81 2030	286 213 81 2040

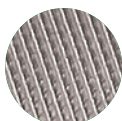

ČTYŘHRANNÝ SQUARE VIERKANT КВАДРАТНЫЙ	PJC 	140	2,4	8	286 213 82 1400	286 213 82 1410	286 213 82 1420	286 213 82 1430	286 213 82 1440
		160	2,4	10	286 213 82 1600	286 213 82 1610	286 213 82 1620	286 213 82 1630	286 213 82 1640
		180	2,7	13	286 213 82 1800	286 213 82 1810	286 213 82 1820	286 213 82 1830	286 213 82 1840
		200	3,3	20	286 213 82 2000	286 213 82 2010	286 213 82 2020	286 213 82 2030	286 213 82 2040

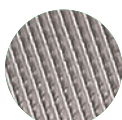

TŘÍHRANNÝ THREESQUARE DREIKANT ТРЕХГРАННЫЙ	PJT 	140	3,5	8	286 213 83 1400	286 213 83 1410	286 213 83 1420	286 213 83 1430	286 213 83 1440
		160	3,5	10	286 213 83 1600	286 213 83 1610	286 213 83 1620	286 213 83 1630	286 213 83 1640
		180	3,9	13	286 213 83 1800	286 213 83 1810	286 213 83 1820	286 213 83 1830	286 213 83 1840
		200	4,7	20	286 213 83 2000	286 213 83 2010	286 213 83 2020	286 213 83 2030	286 213 83 2040

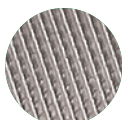

KRUHOVÝ ROUND RUND КРУГЛЫЙ ЗАОСТРЕННЫЙ	PJK 	140	3	8	286 213 84 1400	286 213 84 1410	286 213 84 1420	286 213 84 1430	286 213 84 1440
		160	3	10	286 213 84 1600	286 213 84 1610	286 213 84 1620	286 213 84 1630	286 213 84 1640
		180	3,5	13	286 213 84 1800	286 213 84 1810	286 213 84 1820	286 213 84 1830	286 213 84 1840
		200	4	20	286 213 84 2000	286 213 84 2010	286 213 84 2020	286 213 84 2030	286 213 84 2040

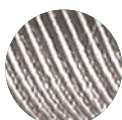

ÚSEČOVÝ HALFROUND HALBRUND ПОЛУКРУГЛЫЙ	PJP 	140	5 x 1,8	8	286 213 85 1400	286 213 85 1410	286 213 85 1420	286 213 85 1430	286 213 85 1440
		160	5 x 1,8	10	286 213 85 1600	286 213 85 1610	286 213 85 1620	286 213 85 1630	286 213 85 1640
		180	6 x 2,2	13	286 213 85 1800	286 213 85 1810	286 213 85 1820	286 213 85 1830	286 213 85 1840
		200	6,5 x 2,5	20	286 213 85 2000	286 213 85 2010	286 213 85 2020	286 213 85 2030	286 213 85 2040





Typ Type Тип	Tvar Shape Form Форма	Délka Length Länge Длина	Průřez Section Querschnitt Сечение	Hmotnost / ks Weight / pc Gewicht / Stk. Вес / Канзас
--------------------	--------------------------------	-----------------------------------	---	--

Sek / Cut / Hieb / Насечка				
0	1	2	3	4

		mm	mm	г/шт
NOŽOVÝ KNIFE MESSER НОЖЕВОЙ	PJN 	140	5,6 x 1,5	8
		160	5,6 x 1,5	10
		180	6 x 2	13
		200	6,8 x 2,2	20

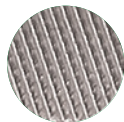
Objednací číslo / Code / Bestell - Nr. / Артикул				
286 213 86 1400	286 213 86 1410	286 213 86 1420	286 213 86 1430	286 213 86 1440
286 213 86 1600	286 213 86 1610	286 213 86 1620	286 213 86 1630	286 213 86 1640
286 213 86 1800	286 213 86 1810	286 213 86 1820	286 213 86 1830	286 213 86 1840
286 213 86 2000	286 213 86 2010	286 213 86 2020	286 213 86 2030	286 213 86 2040



TŘÍHRANNÝ NÍZKÝ BARETTE BARETT БАРЕТНЫЙ	PJTn 	140	5 x 2	8
		160	5 x 2	10
		180	5,8 x 2,3	13
		200	6,2 x 3,5	20

286 213 87 1400	286 213 87 1410	286 213 87 1420	286 213 87 1430	286 213 87 1440
286 213 87 1600	286 213 87 1610	286 213 87 1620	286 213 87 1630	286 213 87 1640
286 213 87 1800	286 213 87 1810	286 213 87 1820	286 213 87 1830	286 213 87 1840
286 213 87 2000	286 213 87 2010	286 213 87 2020	286 213 87 2030	286 213 87 2040

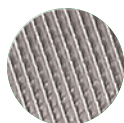

JAZÝČKOVÝ CROSSING VOGELZUNGE ЯЗЫЧКОВЫЙ	PJJ 	140	4,6 x 2	8
		160	4,6 x 2	10
		180	5,7 x 2,2	13
		200	6,5 x 2,5	20

286 213 88 1400	286 213 88 1410	286 213 88 1420	286 213 88 1430	286 213 88 1440
286 213 88 1600	286 213 88 1610	286 213 88 1620	286 213 88 1630	286 213 88 1640
286 213 88 1800	286 213 88 1810	286 213 88 1820	286 213 88 1830	286 213 88 1840
286 213 88 2000	286 213 88 2010	286 213 88 2020	286 213 88 2030	286 213 88 2040



MEČOVÝ SLITTING SCHWERT РОМБОВИДНЫЙ	PJM 	140	5 x 2	8
		160	5 x 2	10
		180	6,5 x 2,2	13
		200	7 x 2,5	20

286 213 89 1400	286 213 89 1410	286 213 89 1420	286 213 89 1430	286 213 89 1440
286 213 89 1600	286 213 89 1610	286 213 89 1620	286 213 89 1630	286 213 89 1640
286 213 89 1800	286 213 89 1810	286 213 89 1820	286 213 89 1830	286 213 89 1840
286 213 89 2000	286 213 89 2010	286 213 89 2020	286 213 89 2030	286 213 89 2040

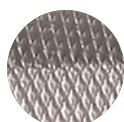

PLOCHÝ - se zaoblenými rohy RE-JOINT FLACHSTUMPF - runde Kante ПЛОСКИЙ - закругленные рабочие грани	PJOZ 	140	5,8 x 1,3	8
		160	5,8 x 1,3	10
		180	6,8 x 1,6	13
		200	7,8 x 1,7	20

286 213 90 1400	286 213 90 1410	286 213 90 1420	286 213 90 1430	286 213 90 1440
286 213 90 1600	286 213 90 1610	286 213 90 1620	286 213 90 1630	286 213 90 1640
286 213 90 1800	286 213 90 1810	286 213 90 1820	286 213 90 1830	286 213 90 1840
286 213 90 2000	286 213 90 2010	286 213 90 2020	286 213 90 2030	286 213 90 2040

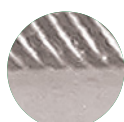

OVÁLOVÝ OVAL ОВАЛЬНЫЙ	PJE 	140	3,5 x 2,5	8
		160	3,5 x 2,5	10
		180	4,2 x 3	13
		200	5 x 3,2	20

286 213 91 1400	286 213 91 1410	286 213 91 1420	286 213 91 1430	286 213 91 1440
286 213 91 1600	286 213 91 1610	286 213 91 1620	286 213 91 1630	286 213 91 1640
286 213 91 1800	286 213 91 1810	286 213 91 1820	286 213 91 1830	286 213 91 1840
286 213 91 2000	286 213 91 2010	286 213 91 2020	286 213 91 2030	286 213 91 2040



SADA JEHLOVÝCH PILNÍKŮ 12DÍLNÁ BEZ DRŽADLA

NEEDLE FILE SET 12-PCS WITHOUT HANDLE
NADELFEILENSATZ 12 STÜCK OHNE HEFT
НАБОР НАДФИП БЕЗ РУЧКИ 12 ШТ

Délka Length Länge Длина	Hmotnost / ks Weight / pc Gewicht / Stk. Вес / Канзас	Sek /Cut / Hieb / Насечка	
mm	ЛґЛ	0	2
140	100	Objednací číslo Code / Bestell - Nr. / Артикул	
		286 213 92 1400	286 213 92 1420



SADA JEHLOVÝCH PILNÍKŮ 6DÍLNÁ BEZ DRŽADLA

NEEDLE FILE SET 6-PCS WITHOUT HANDLE
NADELFEILENSATZ 6 STÜCK OHNE HEFT
НАБОР НАДФИП БЕЗ РУЧКИ 6 ШТ

Délka Length Länge Длина	Hmotnost / ks Weight / pc Gewicht / Stk. Вес / Канзас	Sek /Cut / Hieb / Насечка	
mm	ЛґЛ	0	2
160	75	Objednací číslo Code / Bestell - Nr. / Артикул	
180	100	286 213 93 1600	286 213 93 1620
		286 213 93 1800	286 213 93 1820



SADA JEHLOVÝCH PILNÍKŮ 6DÍLNÁ S DRŽADLEM

NEEDLE FILE SET 6-PCS WITH HANDLE
NADELFEILENSATZ 6 STÜCK MIT HEFT
НАБОР НАДФИП С РУЧКОЙ 6 ШТ

Délka Length Länge Длина	Hmotnost / ks Weight / pc Gewicht / Stk. Вес / Канзас	Sek /Cut / Hieb / Насечка	
mm	ЛґЛ	0	2
160	95	Objednací číslo Code / Bestell - Nr. / Артикул	
180	120	286 213 93 1606	286 213 93 1626
200	155	286 213 93 1806	286 213 93 1826
		286 213 93 2006	286 213 93 2026





CZ

Jehlové pilníky s diamantovým povrchem jsou určeny pro jemné dokončovací operace při výrobě střížných, lisovacích, razících a jiných nástrojů, které jsou vyrobeny z kalené oceli nebo slinutých karbidů. Jsou také vhodné pro uměleckou činnost, mají široké použití pro drobné řemeslníky. Standardně nanášíme střední zrnitost D126.

EN







Needle files with diamond surface are suitable for hand finishing operations at production of embossing, moulding and other tools which are manufactured from hardened steel or from sintered carbide. These files are also suitable for artistic works and have broad use for minute craftsmen. Standardly we produce the middle grit size D 126.

DE

Nadelfeilen mit Diamantoberfläche sind für feine Nacharbeitungsvorgänge bei der Herstellung von Schneid-, Press-, Stanz- und anderen Werkzeugen aus gehärtetem Stahl oder Sinterkarbiden ausgelegt. Sie eignen sich auch für künstlerische Aktivitäten und werden häufig von kleinen Handwerkern eingesetzt. Standardmäßig verwenden wir die mittlere Korngröße D126.

RU

Надфили с алмазной поверхностью предназначены для окончательной чистовой обработки при производстве режущих, прессующих, штамповочных и других инструментов, которые изготовлены из закаленной стали или твердых сплавов. Они также подходят для художественной деятельности и широко используются ремесленниками и различными мастерами. Стандартно мы производим надфили со средней зернистостью D126.

Typ Type Тип	Tvar Shape Form Форма	Délka Length Länge Длина	Průřez Section Querschnitt Сечение	Hmotnost / ks Weight / pc Gewicht / Stk. Вес / Канзас
		mm	mm	г/шт
PLOCHÝ HAND FLACHSTUMPF ПЛОСКИЙ	PJAd 140 	140	5,4 x 1,3	7,5
ČTYŘHRANNÝ SQUARE VIERKANT КВАДРАТНЫЙ	PJCd 140 	140	2,4	7,5
TŘÍHRANNÝ THREESQUARE DREIKANT ТРЕУГОЛЬНЫЙ	PJTd 140 	140	3,5	7,5
KRUHOVÝ ROUND RUND КРУГЛЫЙ	PJKd 140 	140	3	7,5
ÚSEČOVÝ HALFROUND HALBRUND ПОЛУКРУГЛЫЙ	PJPd 140 	140	5,2 x 1,8	7,5
NOŽOVÝ KNIFE MESSER ПЛОСКИЙ НОЖЕВОЙ	PJNd 140 	140	5,6 x 1,5	7,5

Objednací číslo / Code / Bestell - Nr. / Артикул

286 214 80 4126

286 214 82 4126

286 214 83 4126

286 214 84 4126

286 214 85 4126

286 214 86 4126

Délka Length Länge Длина	Hmotnost / ks Weight / pc Gewicht / Stk. Вес / Канзас	Objednací číslo Code / Bestell - Nr. / Артикул
mm	г/шт	
140	85	286 214 96 4126

Délka činné části je 70 mm.
The length of the active part is 70 mm.
Die Länge des aktiven Teils ist 70 mm.
Длина активной части 70 мм.



**CZ**

Používají se pro ostření pilových listů a kotoučových pil. Výjimku tvoří pily s tvrzenými zuby, které nelze ostřit. Lze je použít i pro ostření nářadí. Výjma speciálních pilníků na řetězy motorových pil je vyrábíme s jednoduchým sekem.

EN

These are used to sharpen saw blades and circular saws, with the exception of saws with hardened teeth, which cannot be sharpened. They can also be used to sharpen tools. Other than special files for chainsaw chains, we produce them with a simple cut.

DE

Sie dienen zum Schärfen von Sägeblättern und Kreissägen. Eine Ausnahme bilden Sägen mit gehärteten Zähnen, die nicht geschärft werden können. Sie können auch zum Schärfen von Werkzeugen verwendet werden. Mit Ausnahme von Spezialfeilen für Motorsägeketten produzieren wir diese mit einem einfachen Hieb.

RU

Они используются для заточки ножовочных полотен и кругов пил. Исключение составляют пилы с закаленными зубьями, которые невозможно заточить. Они также могут использоваться для заточки инструментов. За исключением специальных напильников для цепей бензопил, мы производим их с одинарной насечкой.

Typ Type Typ Тип	Tvar Shape Form Форма	Délka Length Länge Длина	Průřez Section Querschnitt Сечение	Hmotnost / ks Weight / pc Gewicht / Stk. Вес / Канзас
		mm	mm	kg

Sek / Cut / Hieb / Насечка
2
3

PLOCHÝ MILL FILE square edges MÜHLSÄGEFEILE flache Kanten ПЛОСКИЙ с прямоугольными гранями	PIO 	150	16 x 3	85
		200	20 x 3,5	150
		250	25 x 4,5	250
		300	30 x 5	420

Objednací číslo / Code / Bestell - Nr. / Артикул

286 212 12 1525
286 212 12 2025
286 212 12 2525
286 212 12 3025



PLOCHÝ univerzální MILL FILE MÜHLSÄGEFEILE ПЛОСКИЙ универсальный	PIU 	200	20 x 3,5	150
		250	25 x 4,5	250
		300	30 x 5	420

286 212 17 2025
286 212 17 2525
286 212 17 3025



PLOCHÝ se zaoblenými rohy MILL FILE round edges MÜHLSÄGEFEILE runde Kanten ПЛОСКИЙ с круглыми гранями	PIB 	150	16 x 3	85
		200	20 x 3,5	150
		250	25 x 4,5	250
		300	30 x 5	420

286 212 18 1525
286 212 18 2025
286 212 18 2525
286 212 18 3025



FARMÁŘSKÝ PILNÍK FARMER'S OWN FARMERFEILE ПЛОСКИЙ личной	PIF 	200	25 x 4,5	210
		250	25 x 4,5	240

286 212 19 2025
286 212 19 2525



TŘÍHRANNÝ VYSOKÝ TAPER REGULAR SÄGEFEILE NORMAL ТРЕХГРАННЫЙ с нормальным конусом	PIV 	150	14	120
		200	16	200

286 212 54 1525
286 212 54 2025

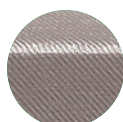

Typ Type Typ Тип

Tvar Shape Form Форма	Délka Length Länge Длина	Průřez Section Querschnitt Сечение	Hmotnost / ks Weight / pc Gewicht / Stk. Вес / Канзас
---------------------------------------	--	--	---

Sek / Cut / Hieb / Насечка
2
3

TŘÍHRANNÝ NÍZKÝ TAPER SLIM SÄGEFEILE SCHMAL ТРЕХГРАННЫЙ с тонким конусом	PIN 	125	8,5	60
		150	10	65
		200	12	140

Objednací číslo / Code / Bestell - Nr. / Артикул

286 212 55 1225
286 212 55 1525
286 212 55 2025

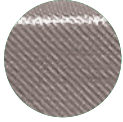

TŘÍHRANNÝ - se zaoblenými rohy BANDSAW FILE - rounded edges BANDSÄGEFEILE - Kanten gerundet ТРЕХГРАННЫЙ с закругленными гранями	PIZ 	150	14,6	160
		200	17	250

286 212 56 1525
286 212 56 2025

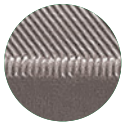

NOŽOVÝ KNIFE MESSER ПЛОСКИЙ НОЖЕВОЙ	PIS 	110	6,5 x 4,8	35
		200	20 x 5	180
		250	25 x 6	310

286 212 74 1125
286 212 74 2025
286 212 74 2525



MEČOVÝ FEATHEREDGE FILE SCHWERTFEILES РОМБИЧЕСКИЙ	PISch 	150	20 x 5	110
		200	25 x 6	200

286 212 77 1525
286 212 77 2025



PILNÍK - na řetězy motorových pil CHAIN SAW FILE KETTENSÄGEFEILEN КРУГЛЫЙ	PIM 	200	3,5	18
		200	4	21
		200	4,5	27
		200	4,8	30
		200	5,2	37
		200	5,5	38

286 212 20 3535
286 212 20 0435
286 212 20 4535
286 212 20 4835
286 212 20 5235
286 212 20 5535

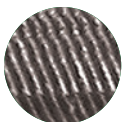



CZ

Jsou podobné říenským pilníkům. Používají se pro jemnější pilování a dokončovací práce, mají křížový sek.

EN

These are similar to workshop files. They are used for finer filing and finishing work; they have a cross cut.

DE

Sie ähneln den Werkstattfeilen. Sie werden für feinere Feil- und Endbearbeitungsarbeiten verwendet, sie haben einen Kreuzrieb.

RU

Они похожи на напильники для мастерских. Они используются для чистового шлифования и окончательных отделочных работ, имеют перекрестную насечку.

Typ Type Typ Тип	Tvar Shape Form Форма	Délka Length Länge Длина	Průřez Section Querschnitt Сечение	Hmotnost / ks Weight / pc Gewicht / Stk. Вес / Канзас
---------------------------	--------------------------------	-----------------------------------	---	--

		mm	mm	g/pc
PLOCHÝ HAND FLACHSTUMPF ПЛОСКИЙ	PPO 	100	12 x 3	35
		150	16 x 4	70
		200	20 x 5	165

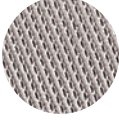

PILLAR PILLAR STIFTENFEILE ШТЫРЬЕВОЙ	PPP 	100	9,5 x 2,4	25
		150	12 x 3	45
		200	16 x 4	95

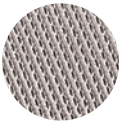

PILLAR zvlášť úzký PILLAR extra narrow STIFTENFEILE besonders schmale Form ПЛОСКИЙ очень узкий	PPPe 	100	4 x 2,4	10
		150	8 x 3	28
		200	10 x 3,5	40

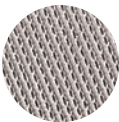

PLOCHOŠPIČATÝ nízký WARDING FLACHSPITZ dünne Form ПЛОСКИЙ узкий суженный	PPW 	100	12 x 1,3	30
		150	16 x 1,9	50
		200	20 x 2,7	120

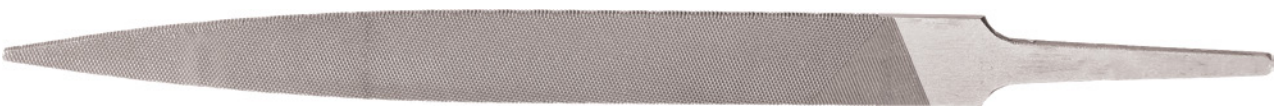
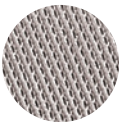

TŘÍHRANNÝ THREESQUARE DREIKANT ТРЕУГОЛЬНЫЙ	PPT 	100	6,3	20
		150	9,3	50

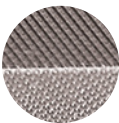

ÚSEČOVÝ HALFROUND HALBRUND ПОЛУКРУГЛЫЙ	PPÚ 	150	16 x 4,7	55
--	---	-----	----------	----

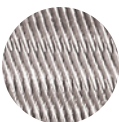

PLOCHÝ - sek na 4 stranách EQUALLING - parallel cut on 4 sides FLACHE AUSGLEICHFEILE - Paralleler Hieb an 4 Seiten РАВНОБОКИЙ - параллельная насечка на 4 сторонах	PPE 	100	10 x 1,2	15
		150	16 x 1,8	30

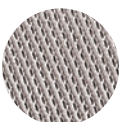

Sek / Cut / Hieb / Насечка		
0	2	4

Objednáací číslo / Code / Bestell - Nr. / Артикул		
286 201 10 1005	286 201 10 1025	286 201 10 1045
286 201 10 1505	286 201 10 1525	286 201 10 1545
286 201 10 2005	286 201 10 2025	286 201 10 2045

286 201 11 1005	286 201 11 1025	286 201 11 1045
286 201 11 1505	286 201 11 1525	286 201 11 1545
286 201 11 2005	286 201 11 2025	286 201 11 2045

286 201 13 1005	286 201 13 1025	286 201 13 1045
286 201 13 1505	286 201 13 1525	286 201 13 1545
286 201 13 2005	286 201 13 2025	286 201 13 2045

286 201 15 1005	286 201 15 1025	286 201 15 1045
286 201 15 1505	286 201 15 1525	286 201 15 1545
286 201 15 2005	286 201 15 2025	286 201 15 2045

286 201 19 1005	286 201 19 1025	286 201 19 1045
286 201 19 1505	286 201 19 1525	286 201 19 1545

286 201 16 1505	286 201 16 1525	286 201 16 1545
-----------------	-----------------	-----------------

-	286 201 23 1025	286 201 23 1045
-	286 201 23 1525	286 201 23 1545



CZ

Používají se pro práci v těžko přístupných místech při výrobě nástrojů a forem. Také je používají modeláři, zlatníci a kovorytci. Mají na obou koncích sekané plochy a střední část bez seku, která slouží k uchopení nástroje. Vyrábíme v délkách 180 mm (rytecké silné) a 150 mm (rytecké slabé).

EN



















































These files are used for work in hard-to-reach places in the production of tools and moulds. They are also used by model-makers, goldsmiths and engravers. They have cut surfaces at both ends; the middle part is free of cuts, and is used to grasp the tool. We produce them in lengths of 180 mm (thick engraving files) and 150 mm (thin engraving files).









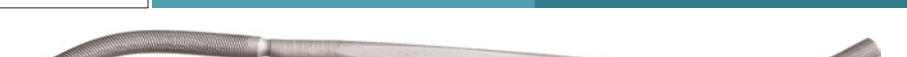



























DE





































Sie werden für Arbeiten an schwer zugänglichen Stellen bei der Herstellung von Werkzeugen und Formen eingesetzt. Sie werden auch von Modellbauern, Goldschmieden und Metallstechern verwendet. Sie haben an beiden Enden Hiebflächen und einen Mittelteil ohne Hieb, der dazu dient, das Werkzeug zu befestigen. Wir produzieren sie in Längen von 180 mm (Gravur stark) und 150 mm (Gravur schwach).

RU

Они используются для работы в труднодоступных местах при производстве инструментов и форм. Они также используются модельстами, ювелирами и гравёрами по металлу. Они имеют на обоих концах поверхности с насечкой и среднюю часть без насечки, которая используется для захвата инструмента. Мы производим их длиной 180 мм (гравирование сильное) и 150 мм (гравирование слабое).

Typ Type Тип	Tvar Shape Form Форма	Délka Length Länge Длина mm	Hmotnost / ks Weight / pc Gewicht / Stk. Вес / Канзас г/шт	Sek / Cut / Hieb / Насечка		Tvar Shape Form Форма	
				0	2		
				Objednací číslo / Code / Bestell - Nr. / Артикул			
18710		180	35	286 215 18 7100	286 215 18 7102		
							
18712		180	35	286 215 18 7120	286 215 18 7122		
							
18713		180	35	286 215 18 7130	286 215 18 7132		
							
18731		180	35	286 215 18 7310	286 215 18 7312		
							
18741		180	35	286 215 18 7410	286 215 18 7412		
							
18750		180	35	286 215 18 7500	286 215 18 7502		
							
18762		180	35	286 215 18 7620	286 215 18 7622		
							
18763		180	35	286 215 18 7630	286 215 18 7632		
							
18764		180	35	286 215 18 7640	286 215 18 7642		
							
18771		180	35	286 215 18 7710	286 215 18 7712		
							
18781		180	35	286 215 18 7810	286 215 18 7812		
							
18782		180	35	286 215 18 7820	286 215 18 7822		
							
18783		180	35	286 215 18 7830	286 215 18 7832		
							

Typ Type Typ Тип	Tvar Shape Form Форма	Délka Length Länge Длина	Hmotnost / ks Weight / pc Gewicht / Stk. Вес / Канзас	Sek / Cut / Hieb / Насечка		Tvar Shape Form Форма	
				0	2		
		mm	ЛґЛ	Objednací číslo / Code / Bestell - Nr. / Артикул			
15910		150	15	286 215 15 9100	286 215 15 9102		
							
15914		150	15	286 215 15 9140	286 215 15 9142		
							
15915		150	15	286 215 15 9150	286 215 15 9152		
							
15918		150	15	286 215 15 9180	286 215 15 9182		
							
15930		150	15	286 215 15 9300	286 215 15 9302		
							
15943		150	15	286 215 15 9430	286 215 15 9432		
							
15951		150	15	286 215 15 9510	286 215 15 9512		
							
15952		150	15	286 215 15 9520	286 215 15 9522		
							
15961		150	15	286 215 15 9610	286 215 15 9612		
							

Typ Type Typ Тип	Tvar Shape Form Форма	Délka Length Länge Длина	Hmotnost / ks Weight / pc Gewicht / Stk. Вес / Канзас	Sek / Cut / Hieb / Насечка		Tvar Shape Form Форма
				0	2	
		mm	Л/Л	Objednací číslo / Code / Bestell - Nr. / Артикул		
15964		150	15	286 215 15 9640	286 215 15 9642	
						
15971		150	15	286 215 15 9710	286 215 15 9712	
						
15972		150	15	286 215 15 9720	286 215 15 9722	
						
15973		150	15	286 215 15 9730	286 215 15 9732	
						
15975		150	15	286 215 15 9750	286 215 15 9752	
						
15980		150	15	286 215 15 9800	286 215 15 9802	
						
15981		150	15	286 215 15 9810	286 215 15 9812	
						
15982		150	15	286 215 15 9820	286 215 15 9822	
						
15985		150	15	286 215 15 9850	286 215 15 9852	
						



CZ

SKI pilníky patří mezi základní vybavení pro údržbu lyží a snowboardů. Z naší široké nabídky typů i délek si vybere každý: začátečník, profesionál i lyžařský servis. Dostupné rovněž v chromové úpravě. Na zakázku je vyrábíme v libovolných délkách.

EN

SKI files are part of any basic ski and snowboard maintenance kit. Our wide range of types and lengths offers something for everyone: beginners, professionals and ski service technicians. Also available in a chrome finish. We make them in any lengths to order.

DE

SKI-Feilen gehören zur Grundausrüstung der Wartung von Skiern und Snowboards. Jeder kann aus unserer großen Auswahl an Typen und Längen wählen: Anfänger-, Profi- und Skiservice. Auch in Chrom erhältlich. Auf Anfrage stellen wir sie in beliebiger Länge her.

RU

Напильники для работы со скользящей поверхностью лыж являются одними из основных инструментов для технического обслуживания лыж и сноубордов. Из нашего широкого спектра типов и длины сможет выбрать каждый: любитель, профессионал и лыжный сервис. Также доступны с хромированной отделкой. Мы изготавливаем их на заказ любой длины.

Typ Type Typ Тип	Tvar Shape Form Форма	Délka Length Länge Длина	Průřez Section Querschnitt Сечение	Hmotnost / ks Weight / pc Gewicht / Stk. Вес / Канзас
		mm	mm	кг

Sek / Cut / Hieb / Насечка

1

2

Objednací číslo / Code / Bestell - Nr. / Артикул

PLOCHÝ SKI FILE FLACHSTUMPF ПЛОСКИЙ	SKI	150	15 x 3	60
		200	20 x 3,5	100
		250	25 x 4,5	210

286 211 35 1525

286 211 35 2010

286 211 35 2510

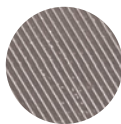

PLOCHÝ SKI FILE FLACHSTUMPF ПЛОСКИЙ	SKIP	150	15 x 3	75
		200	20 x 3,5	85

286 211 35 0000

286 211 35 0002

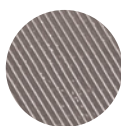

PLOCHÝ SKI FILE FLACHSTUMPF ПЛОСКИЙ	SKIPS	100	25 x 4,5	65
		120	25 x 4,5	90

286 211 35 6101

286 211 35 6120

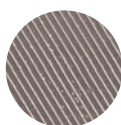

PLOCHÝ - s frézovanými kruhovými zuby MILLED SKI FILE - curved tooth FLACHSTUMPF - radial verzahnt ПЛОСКИЙ - с круговой насечкой	PFL	100	30 x 4,3	60
---	-----	-----	----------	----

286 211 35 1015

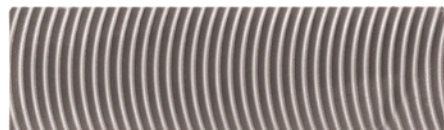
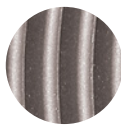

PLOCHÝ - s frézovanými kruhovými zuby MILLED SKI FILE - curved tooth FLACHSTUMPF - radial verzahnt ПЛОСКИЙ - с круговой насечкой	PFL	300	30 x 4,3	255
		350	35 x 5	290

286 211 39 3010

286 211 39 3510

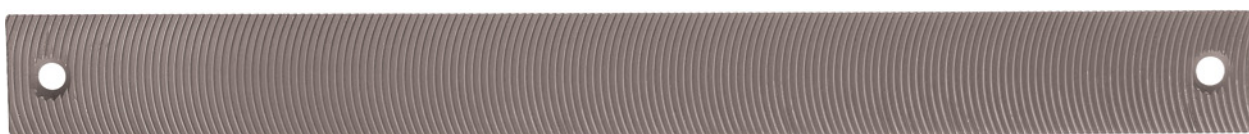
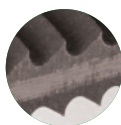



CZ

Používají se pro vytvoření drážek například na tupé straně čepele nože, na pažbách zbraní a podobně. Mimořádný sek u těchto pilníků tvoří podélné drážky, které se křížují v úhlu 90° s příčnými drážkami. Vhodné pro dřevo, měkké kovy a ocel.

EN

Used to create grooves, for example on the blunt side of a knife blade, on the stocks of guns, etc. The extraordinary cut on these files consists of longitudinal grooves that intersect with transversal grooves at a 90° angle. Suitable for wood, soft metals and steel.

DE

Sie werden verwendet, um Rillen zu erzeugen, beispielsweise auf der stumpfen Seite der Messerklinge, auf Kolben von Waffen und dergleichen. Einen außergewöhnlichen Hieb bei diesen Feilen bilden die Längsrillen, die sich in einem Winkel von 90° mit den Querrillen kreuzen. Geeignet für Holz, Weichmetalle und Stahl.

RU

Они используются для создания канавок, например, на тупой стороне лезвия ножа, на прикладах оружия и тому подобного применения. Необычная насечка в этих напильниках образована продольными канавками, которые пересекаются под углом 90° с поперечными канавками. Рекомендуются для дерева, мягких металлов и стали.

Typ Type Тип	Tvar Shape Form	Délka Length Länge Длина	Průřez Section Querschnitt Сечение	Hmotnost / ks Weight / pc Gewicht / Stk. Вес / Канзас
		mm	mm	г/шт
PLOCHÝ HAND FLACHSTUMPF ПЛОСКИЙ	PFD 	150	12,7 x 5	75

Sek / Cut / Hieb / Насечка			
00	0	1	2
Počet drážek na cm / Number of grooves per cm / Fäden pro cm / Число канавок на см			
8	12	16	20
Rozteč - mm / Pitch - mm / Teilung - mm / шаг - мм			
1,25	0,85	0,65	0,55
Objednáací číslo / Code / Bestell - Nr. / Артикул			
286 211 36 1500	286 211 36 1504	286 211 36 1515	286 211 36 1525

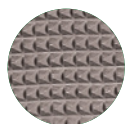



CZ

Speciální pilníky určené pro jemnou ruční práci při výrobě hudebních nástrojů.

EN

Special files designed for fine manual work when making musical instruments.

DE

Spezielle Feilen für feine Handarbeit bei der Herstellung von Musikinstrumenten.

RU

Специальные напильники, предназначенные для тонкой ручной работы при производстве музыкальных инструментов.

Typ Type Typ Тип	Tvar Shape Form Форма	Délka Length Länge Длина	Průřez Section Querschnitt Сечение	Hmotnost / ks Weight / pc Gewicht / Stk. Вес / Канзас	Počet zubů / cm Weight / pc Gewicht / Stk. Вес / Канзас
---------------------------	--------------------------------	-----------------------------------	---	--	--

mm

mm

g

Sek / Cut / Hieb / Насечка

2

4

Objednací číslo / Code / Bestell - Nr. / Артикул

Plochý s rádiusem FLAT with radius FLACH mit Radius Плоский с радиусом	PHP	150	16 x 4	100	26
---	-----	-----	--------	-----	----

286 218 00 1545



PLOCHÝ HAND FLACHSTUMPF ПЛОСКИЙ	PHO	150	8 x 2	20	18
--	-----	-----	-------	----	----

286 218 02 1520



TŘÍHRANNÝ THREESQUARE DREIKANT ТРЕХГРАННЫЙ	PHTc	150	4	15	29
---	------	-----	---	----	----

286 218 01 1520

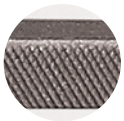

KRUHOVÝ ROUND RUND КРУГЛЫЙ ЗАОСТРЕННЫЙ	PHKc	110	2,1	10	34
		110	2,4	11	34
		110	2,6	12	34
		110	3	13	34
		110	3,4	14	34

286 218 21 1140

286 218 24 1140

286 218 26 1140

286 218 30 1140

286 218 34 1140





CZ

Speciální ručně vyráběné nástroje k upnutí do vrtaček a dalšího elektrického nářadí. Rotační pilníky jsou určeny k opracování měkkých i tvrdých kovů. Rotační rašple jsou určeny k opracování měkkého i tvrdého dřeva. Použití maximálně při 3000 otáček za minutu.

EN

Special handmade tools designed to be clamped in drills and other electrical tools. Rotary files are designed for working soft and hard metals. Rotary rasps are designed for working soft and hard woods. Used at a maximum of 3000 rotations per minute.

DE

Spezielle handgefertigte Werkzeuge zum Einspannen in Bohrern und anderen Elektrowerkzeugen. Rotationsfeilen sind für die Verarbeitung von weichen und harten Metallen ausgelegt. Rotationsraspeln sind für die Verarbeitung von weichem und hartem Holz ausgelegt. Bei maximal 3000 U/min

RU

Специальные инструменты ручной работы, предназначенные для зажима в дрелях и других электроинструментах. Вращающиеся напильники предназначены для обработки мягких и твердых металлов. Вращающиеся рашпили предназначены для обработки мягкой и твердой древесины. Используется максимум 3000 оборотов в минуту.

ROTAČNÍ PILNÍKY SLABÉ
ROTARY FILES THIN
ROTATIONSFEILEN - DÜNN
БОРФРЕЗЫ ТОНКИЕ

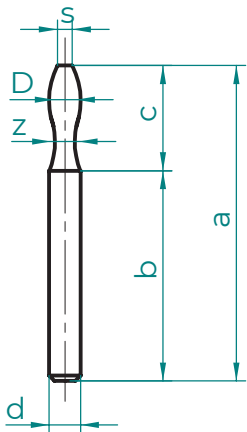

Typ Type Typ Тип	Délka Length Länge Длина	Hmotnost / ks Weight / pc Gewicht / Stk. Вес / Канзас	Objednací číslo Code / Bestell - Nr. / Артикул
---------------------------	-----------------------------------	--	---

a ... (mm) 60 ЛГЛ

	b	c	d	D	s	z	
1	35	25	6	6,5	-	-	12
2	40	20	6	6,2	-	-	12
3	45	15	6	6,2	1,5	-	12
4	30	25	6	6,2	0,5	-	12
5	35	30	6	6,5	3,5	-	12
6	38	23	6	6,2	1,5	4,2	12
7	42	40	6	6,2	0,5	4,2	12
8	56	7	6	4,2	3,5	-	12
9	51	9	6	6,2	-	-	12
10	55	5	6	6,2	-	-	12

286 217 11 0631
286 217 11 0632
286 217 11 0633
286 217 11 0634
286 217 11 0635
286 217 11 0636
286 217 11 0637
286 217 11 0638
286 217 11 0639
286 217 11 0630



Délka Length Länge Длина	Hmotnost / ks Weight / pc Gewicht / Stk. Вес / Канзас	Obsahuje Include Inhalt Количество	Objednací číslo Code / Bestell - Nr. / Артикул
-----------------------------------	--	---	---

mm ЛГЛ

Rotační pilníky slabé - ruční sek
HAND CUT / HANDBIEB / РУЧНАЯ НАСЕЧКА

60	115	1, 3, 5, 6, 8, 9	286 217 99 6310
----	-----	------------------	-----------------

Rotační pilníky slabé - diamantové
DIAMOND / DIAMANT / АЛМАЗНЫЕ

60	115	1, 3, 5, 6, 8, 9	286 214 99 6310
----	-----	------------------	-----------------



ROTAČNÍ PILNÍKY SILNÉ
ROTARY FILES THICK
ROTATIONSFEILEN - STARK
БОРФРЕЗЫ ТОЛСТЫЕ

Typ Type Typ Тип	Délka Length Länge Длина	Hmotnost / ks Weight / pc Gewicht / Stk. Вес / Канзас
----------------------------------	--	---

Objednací číslo
Code / Bestell - Nr. / Артикул

a ... (mm) 60

ЛГЛ

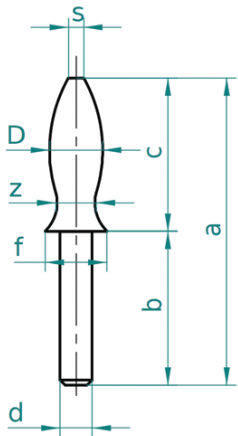

	b	c	d	D	s	z	f	
1	30	30	6	12,5	-	-	-	40
2	30	30	6	12	2	-	-	40
3	40	20	6	12	-	-	9,5	25
4	40	20	6	12	-	8,5	11,5	25
5	50	10	6	12	-	-	-	25
6	40	20	6	12	2	-	-	25
7	30	30	6	12	6	-	-	40
8	30	30	6	12,5	2	-	-	40
9	30	30	6	12	2	-	-	40
10	30	30	6	11	2	8	11,5	40

286 217 12 0701

286 217 12 0702

286 217 12 0703

286 217 12 0704

286 217 12 0705

286 217 12 0706

286 217 12 0707

286 217 12 0708

286 217 12 0709

286 217 12 0700



1

2

3

4

5

6

7

8

9

10

Délka Length Länge Длина	Hmotnost / ks Weight / pc Gewicht / Stk. Вес / Канзас	Obsahuje Include Inhalt Количество	Objednací číslo Code / Bestell - Nr. / Артикул
--	---	--	--

mm

ЛГЛ

Rotační pilníky silné - ruční sek

HAND CUT / HANDBIEB / РУЧНАЯ НАСЕЧКА

60	180	1, 5, 7, 8, 9, 10	286 217 99 7010
----	-----	-------------------	-----------------

286 217 99 7010

Rotační pilníky silné - diamantové

DIAMOND / DIAMANT / АЛМАЗНЫЕ

60	180	1, 5, 7, 8, 9, 10	286 214 99 7010
----	-----	-------------------	-----------------

286 214 99 7010



ROTAČNÍ RAŠPLE
 ROTARY RASPS
 ROTATIONSRASPELN - STARK
 БОРФРЕЗЫ РАШПИЛЬНЫЕ

Typ Type Typ Тип	Délka Length Länge Длина				Hmotnost / ks Weight / pc Gewicht / Stk. Вес / Канзас			
---------------------------	-----------------------------------	--	--	--	--	--	--	--

a ... (mm) 60

лғл

Objednací číslo
 Code / Bestell - Nr. / Артикул

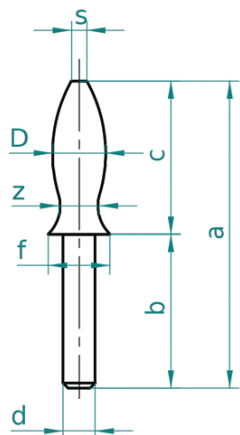

	b	c	d	D	s	z	f	
1	30	30	6	12,5	-	-	-	40
2	30	30	6	12	2	-	-	40
3	40	20	6	12	-	-	9,5	25
4	40	20	6	12	-	8,5	11,5	25
5	50	10	6	12	-	-	-	25
6	40	20	6	12	2	-	-	25
7	30	30	6	12	6	-	-	40
8	30	30	6	12,5	2	-	-	40
9	30	30	6	12	2	-	-	40
10	30	30	6	11	2	8	11,5	40

286 221 12 0701
286 221 12 0702
286 221 12 0703
286 221 12 0704
286 221 12 0705
286 221 12 0706
286 221 12 0707
286 221 12 0708
286 221 12 0709
286 221 12 0700

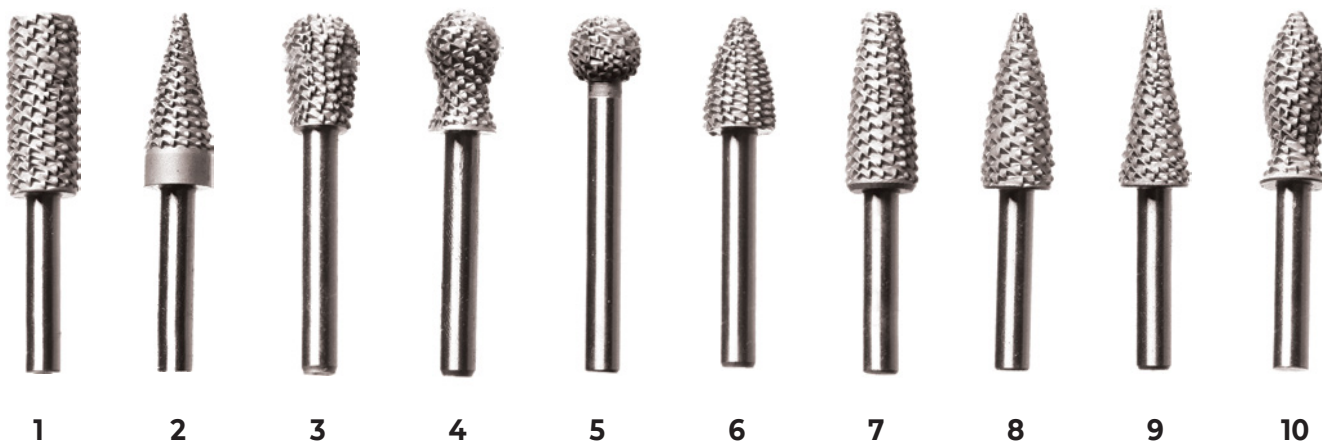

ROTAČNÍ RAŠPLE
 ROTARY RASPS
 ROTATIONSRASPELN - STARK
 БОРФРЕЗЫ РАШПИЛЬНЫЕ

Délka Length Länge Длина	Hmotnost / ks Weight / pc Gewicht / Stk. Вес / Канзас	Obsahuje Include Inhalt Количество	Objednací číslo Code / Bestell - Nr. / Артикул
mm	лғл	лғл	
60	180	1, 5, 7, 8, 9, 10	286 221 99 7010





CZ

Slouží k údržbě koňských kopyt. Na jedné straně jsou opatřeny pilníkovým zubem a na straně druhé rašplovým zubem.

EN

Used to maintain horse's hooves. They have a file tooth on one side and a rasp tooth on the other.

DE

Werden zur Pflege von Pferdehufen verwendet. Sie sind auf einer Seite mit Feilzähnen und auf der anderen Seite mit Raspelzähnen versehen.

RU

Используются для обработки копыт лошадей. На одной стороне находится зуб напильника, а на другой стороне – ёрш.

Typ Type Тур Тип	Tvar Shape Form Форма	Délka Length Länge Длина	Šířka Width Breite ширина	Hmotnost / ks Weight / pc Gewicht / Stk. Вес / Канзас
---------------------------	--------------------------------	-----------------------------------	------------------------------------	--

Objednací číslo
Code / Bestell - Nr. / Артикул

		mm	mm	кг/л
PODKOVÁŘSKÁ RAŠPLE se stopkou HORSE RASPS with a tang HUFRASPELN mit Angel ПОДКОВНЫЕ РАШПИЛЫ С ХВОСТОВИКОМ	PRH - S 	200	40 x 8,5	400
		350	45 x 6,5	650
		430	45 x 6,5	980

286 229 71 2005
286 229 71 3505
286 229 71 4305

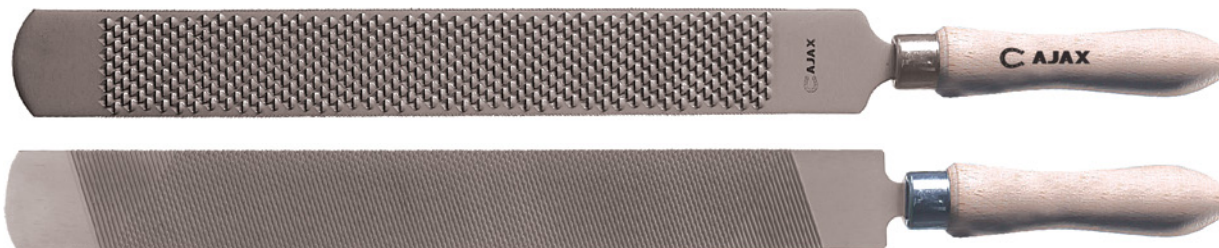
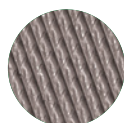

SCAN & PLAY





CZ

Rašple se primárně používají k opracování dřeva, ale lze je použít i na jiné měkké materiály. Nejvíce je využijí truhláři, modeláři a kutilové. Na poptávku je lze vyrobit i v jemnějších či hrubších secích. Strojně sekané rašple se vyznačují geometricky přesnou linií seku.

EN

Rasps are primarily used for woodworking, but can also be used on other soft materials. They are mostly used by carpenters, model-makers and handymen. They can also be made in finer or coarser cuts on request. Machine-cut rasps have a geometrically precise cut line.

DE

Raspseln werden hauptsächlich für die Holzbearbeitung verwendet, können aber auch für andere weiche Materialien verwendet werden. Sie werden hauptsächlich von Tischlern, Modellbauern und Heimwerkern benutzt. Auf Anfrage können sie in feineren oder gröberen Hieben hergestellt werden. Maschinengehauene Raspseln zeichnen sich durch eine geometrisch präzise Hieblinie aus.

RU

Рашпили в основном используются для деревообработки, но также могут использоваться и для других мягких материалов. Они в основном используются плотниками, моделерами и ремесленниками. По запросу их можно производить с более тонкой или грубой насечкой. Промышленно изготовленные рашпили с насечкой характеризуются геометрически точной линией насечки.

SCAN & PLAY



Typ Type Тип	Tvar Shape Forma	Délka Length Länge Длина	Průřez Section Querschnitt Сечение	Hmotnost / ks Weight / pc Gewicht / Stk. Вес / Канзас
--------------------	------------------------	-----------------------------------	---	--

PLOCHÁ RAŠPLE HAND FLACHSTUMPF ПЛОСКИЙ	PRO 	150	16 x 4,5	100
		200	20 x 4,5	200
		250	25 x 7	330
		300	30 x 7	430

Sek / Cut / Hieb / Насечка

2

Objednací číslo / Code / Bestell - Nr. / Артикул

286 221 74 1525
286 221 74 2025
286 221 74 2525
286 221 74 3025

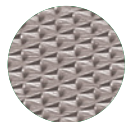

ÚSEČOVÁ RAŠPLE HALFROUND HALBRUND ПОЛУКРУГЛЫЙ	PRP 	150	16 x 6	100
		200	20 x 6,5	170
		250	25 x 8	280
		300	30 x 10	450

286 221 75 1525
286 221 75 2025
286 221 75 2525
286 221 75 3025

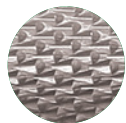

KRUHOVÁ RAŠPLE ROUND RUND КРУГЛЫЙ	PRK 	150	6	80
		200	8	110
		250	10	170
		300	12	300

286 221 77 1525
286 221 77 2025
286 221 77 2525
286 221 77 3025



Sek 1 a 3 vyrobíme na poptávku.

The cuts 1 and 3 will be produced upon request.

Auf Grund einer Anfrage lieferbar auch im Maschinenhieb Nr. 1 und 3.

Разделы 1 и 3 производятся по запросу.

Délka Length Länge Длина	Hmotnost / ks Weight / pc Gewicht / Stk. Вес / Канзас	Sek / Cut / Hieb / Насечка
mm	кг	2
150	310	Objednací číslo Code / Bestell - Nr. / Артикул
200	510	286 221 93 1525
250	840	286 221 93 2025
		286 221 93 2525





CZ

Rašple se primárně používají k opracování dřeva, ale lze je použít i na jiné měkké materiály. Nejvíce je využijí truhláři, modeláři a kutilové. Na poptávku je lze vyrobit i v jemnějších či hrubších secích. Ručně sekané rašple se vyznačují nepravidelnou linií seku, kterou ocení zejména profesionálové.

EN

Rasps are primarily used for woodworking, but can also be used on other soft materials. They are mostly used by carpenters, model-makers and handymen. They can also be made in finer or coarser cuts on request. Hand-cut rasps have an irregular cut line, which is particularly appreciated by professionals.

DE

Raspeeln werden hauptsächlich für die Holzbearbeitung verwendet, können aber auch für andere weiche Materialien verwendet werden. Sie werden hauptsächlich von Tischlern, Modellbauern und Heimwerkern benutzt. Auf Anfrage können sie in feineren oder gröberen Hieben hergestellt werden. Handgehauene Raspeeln zeichnen sich durch eine unregelmäßige Hieblinie aus, die besonders von Profis geschätzt wird.

RU

Ращпили в основном используются для деревообработки, но также могут использоваться и для других мягких материалов. Они в основном используются плотниками, модельерами и ремесленниками. По запросу их можно производить с более тонкой или грубой насечкой. Ращпили с ручной насечкой характеризуются нерегулярной линией насечки, что особенно ценится профессионалами.

SCAN & PLAY



Typ Type Typ Тип	Tvar Shape Form Форма	Délka Length Länge Длина	Průřez Section Querschnitt Сечение	Hmotnost / ks Weight / pc Gewicht / Stk. Вес / Канзас	Sek / Cut / Hieb / Насечка			
		mm	mm	г/шт	1	2	3	4

					Objednací číslo / Code / Bestell - Nr. / Артикул			
PLOCHÁ RAŠPLE HAND FLACHSTUMPF ПЛОСКИЙ	PRO 	100	10 x 3	60	-	-	-	286 221 74 1041
		150	16 x 4	100	-	-	286 221 74 1531	286 221 74 1541
		200	20 x 5	200	-	286 221 74 2021	286 221 74 2031	286 221 74 2041
		250	25 x 7	330	286 221 74 2511	286 221 74 2521	286 221 74 2531	286 221 74 2541
		300	30 x 7	430	286 221 74 3011	286 221 74 3021	286 221 74 3031	286 221 74 3041

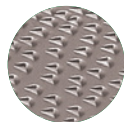

ÚSEČOVÁ RAŠPLE HALFROUND HALBRUND ПОЛУКРУГЛЫЙ	PRP 	100	10 x 3	60	-	-	-	286 221 75 1041
		150	16 x 6	100	-	-	286 221 75 1531	286 221 75 1541
		200	20 x 6,5	170	-	286 221 75 2021	286 221 75 2031	286 221 75 2041
		250	25 x 8	280	286 221 75 2511	286 221 75 2521	286 221 75 2531	286 221 75 2541
		300	30 x 10	450	286 221 75 3011	286 221 75 3021	286 221 75 3031	286 221 75 3041



ÚSEČOVÁ KABINETNÍ RAŠPLE CABINET RASP KABINETTRASPEL ПОЛУКРУГЛЫЙ СЖАТЫЙ	PRPk 	200	25 x 6	170	-	286 221 76 2021	286 221 76 2031	286 221 76 2041
		250	29 x 6	280	286 221 76 2511	286 221 76 2521	286 221 76 2531	286 221 76 2541



KRUHOVÁ RAŠPLE ROUND RUND КРУГЛЫЙ	PRK 	100	4	40	-	-	-	286 221 77 1041
		150	6	80	-	-	286 221 77 1531	286 221 77 1541
		200	8	110	-	286 221 77 2021	286 221 77 2031	286 221 77 2041
		250	10	170	286 221 77 2511	286 221 77 2521	286 221 77 2531	286 221 77 2541
		300	12	300	286 221 77 3011	286 221 77 3021	286 221 77 3031	286 221 77 3041



Délka Length Länge Длина	Hmotnost / ks Weight / pc Gewicht / Stk. Вес / Канзас	Sek / Cut / Hieb / Насечка
mm	г/шт	3
150	300	Objednací číslo Code / Bestell - Nr. / Артикул 286 221 94 1531
150	440	286 221 95 1531
100	300	286 221 96 1031



Typ Type Typ Тип	Tvar Shape Form Форма	Délka Length Länge Длина	Hmotnost / ks Weight / pc Gewicht / Stk. Вес / Канзас
---------------------------	--------------------------------	-----------------------------------	--

mm ЛґЛ

JMR 1		80	50
-------	---	----	----

JMR 2		80	50
-------	---	----	----

JMR 3		80	50
-------	---	----	----

JMR 4		80	50
-------	---	----	----

JMR 5		80	50
-------	---	----	----

JMR 6		80	50
-------	---	----	----

JMR 7		80	50
-------	---	----	----

JMR 8		80	50
-------	---	----	----

Sek / Cut / Hieb / Насечка

3

Objednací číslo / Code / Bestell - Nr. / Артикул

286 221 08 0131



286 221 08 0231



286 221 08 0331



286 221 08 0431



286 221 08 0531



286 221 08 0631



286 221 08 0731



































286 221 08 0831









JMR 80/3R
MODELÁŘSKÁ SADA JEDNOSTRANNÁ
RIFFELRASPELSATZ
SET FOR MODELLERS
НАБОРЫ ДЛЯ МОДЕЛИСТОВ

Délka Length Länge Длина	Hmotnost / ks Weight / pc Gewicht / Stk. Вес / Канзас	Sek / Cut / Hieb / Насечка
mm	ЛґЛ	3
80	420	Objednací číslo Code / Bestell - Nr. / Артикул 286 221 98 0831



Typ Type Тип	Tvar Shape Форма	Délka Length Länge Длина	Hmotnost / ks Weight / pc Gewicht / Stk. Вес / Канзас	Sek / Cut / Hieb / Насечка	Tvar Shape Форма
		mm	г/к	3	
				Objednací číslo / Code / Bestell - Nr. / Артикул	
MR 1		180	30		
				286 221 18 0131	
MR 2		180	30		
				286 221 18 0231	
MR 3		180	30		
				286 221 18 0331	
MR 4		180	30		
				286 221 18 0431	
MR 5		180	30		
				286 221 18 0531	
MR 6		180	30		
				286 221 18 0631	
MR 7		180	30		
				286 221 18 0731	
MR 8		180	30		
				286 221 18 0831	



Typ Type Тип	Tvar Shape Форма	Délka Length Länge Длина	Hmotnost / ks Weight / pc Gewicht / Stk. Вес / Канзас
		mm	г/шт
RJA		160	17
RJO		160	17
RJT		160	17
RJK		160	17
RJP		160	17
RJJ		160	17

Sek / Cut / Hieb / Насечка

3

Objednací číslo / Code / Bestell - Nr. / Артикул

286 221 80 1631



286 221 81 1631



286 221 83 1631



286 221 84 1631



286 221 85 1631



286 221 88 1631



Délka Length Länge Длина	Hmotnost / ks Weight / pc Gewicht / Stk. Вес / Канзас	Sek / Cut / Hieb / Насечка
mm	г/шт	3
160	120	Objednací číslo Code / Bestell - Nr. / Артикул 286 221 97 1636





CZ

Naše ocílky nabízíme v několika délkách, profílech a hrubostech. Samotná hrubost ocílky je dána počtem zubů na centimetr. Vhodné pro domácí i profesionální použití.

EN

We offer our sharpening steels in several lengths, profiles and degrees of coarseness. The actual coarseness of a sharpening steel depends on the number of teeth per centimetre. Suitable for home and professional use.

DE

Wir bieten unsere Messerstähe in verschiedenen Längen, Profilen und Rauheiten an. Die Rauheit des Stahls selbst ergibt sich aus der Anzahl der Zähne pro Zentimeter. Geeignet für den privaten und beruflichen Gebrauch.

RU

Наши стальные бруски мы предлагаем в нескольких вариантах с различной длиной, профилем и шероховатостью. Шероховатость самого стального бруска определяется количеством зубов на сантиметр. Подходит для домашнего и профессионального использования.

Typ Type Typ Тип	Tvar Shape Form Форма	Délka Length Länge Длина	Průřez Section Querschnitt Сечение	Hmotnost / ks Weight / pc Gewicht / Stk. Вес / Канзас
---------------------------	--------------------------------	-----------------------------------	---	--

mm mm ЛгЛ

KULATÁ OCÍLKA BUTCHER STEEL, ROUND FLEISCHER STAHL, RUND КРУГЛЫЙ		200	12	260
		250	12	300
		300	12	340

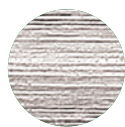

OVÁLNÁ OCÍLKA BUTCHER STEEL, OVAL FLEISCHER STAHL, OVAL ОВАЛЬНЫЙ		250	20 x 10	350
		300	20 x 10	400

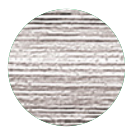

OVÁLNÁ OCÍLKA PROFÍ BUTCHER STEEL, OVAL PROFÍ FLEISCHER STAHL, OVAL PROFÍ ОВАЛЬНЫЙ ПРОФИ		300	20 x 10	390
---	--	-----	---------	-----

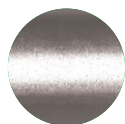

Objednací číslo
Code / Bestell - Nr. / Артикул

286 219 60 2025

286 219 60 2525

286 219 60 3025

286 219 70 2505

286 219 70 3005

286 219 70 3006



CZ

Na základě poptávky zákazníka, v podobě výkresu nebo vzorku, jsme schopni vyrobit požadovaný produkt.

EN

Upon request, as drawing or sample, we are able to manufacture required product.

DE

Aufgrund der Nachfrage des Kunden (in der Form einer Zeichnung oder eines Musters) sind wir imstande das verlangte Produkt zu erzeugen.

RU

На основании запроса заказчика в форме чертежа или образца мы способны изготовить требуемую продукцию.



CZ

Naše produkty můžeme na přání zákazníka nabídnout i s chromovým povrchem.

Hlavní výhody chromu:

- Vysoká tvrdost: cca 1000 HV (69 HRC) nebo vyšší
- Vysoká otěruvzdornost: 5-6 TWI
- Dobrá protikorozní odolnost
- Nízký součinitel tření: tvrdý chrom s ocelí, statický 0,19
- Nepřilnavý povrch
- Prodlužuje životnost produktu

EN

We can also offer our products with a chrome finish at the customer's request.

Main advantages of chrome:

- High hardness: approx. 1000 HV (69 HRC) or higher
- High abrasion resistance: 5-6 TWI
- Good anti-corrosion resistance
- Low friction coefficient: hard chrome with steel, static 0.19
- Non-stick surface
- Prolongs product lifetime

DE

Auf Kundenwunsch können wir unsere Produkte auch verchromt anbieten.

Hauptvorteile von Chrom:

- Hohe Härte: ca. 1000 HV (69 HRC) oder höher
- Hohe Abriebfestigkeit: 5-6 TWI
- Gute Korrosionsbeständigkeit
- Niedriger Reibungskoeffizient: Hartchrom mit Stahl, statisch 0,19
- Antihaf-Oberfläche
- Verlängert die Produktlebensdauer

RU

По желанию заказчика мы также можем предложить нашу продукцию с хромированной отделкой.

Основные преимущества хрома:

- Высокая твердость: около 1000 HV (69 HRC) или выше
- Высокая износостойкость: 5-6 TWI
- Прекрасная устойчивость к коррозии
- Низкий коэффициент трения: твердый хром со сталью, статический 0,19
- Антипригарное покрытие
- Продлевает срок службы изделия



CZ
Ergonomická držadla vhodná pro pohodlnou a bezpečnou práci s dílenskými pilníky.

EN
Ergonomic handles suitable for comfortable and safe work with workshop files.

DE
Ergonomische Griffe für komfortables und sicheres Arbeiten mit Werkstattfeilen.

RU
Эргономичные ручки подходят для комфортной и безопасной работы с напильниками для мастерских.



CZ
Kartáč slouží k snadnému čištění pilníků zanesených kovovými pilinami.

EN
The brush is used to easily clean files clogged with metal shavings.

DE
Die Bürste dient zur einfachen Reinigung von mit Metallsägemehl verschmierten Feilen.

RU
Щетка используется для простой очистки напильников, забитых металлическими опилками.



CZ
Univerzální plastové držadlo pro jehlové pilníky, jehlové pilníky diamant a jehlové rašple.

EN
Universal plastic handle for needle files, diamond files and needle rasps.

DE
Universeller Kunststoffgriff für Nadelfeilen, Diamantfeilen und Nadelraspeln.

RU
Универсальная пластиковая ручка для надфилей, алмазных напильников и рашпелей.



CZ
Karosářský hoblík – ergonomicky tvarovaný držák umožňuje individuální upínání karosářských plátků k přizpůsobení tvaru opracovávaného povrchu. Lehká stabilní konstrukce z hliníku.

EN
Holder – this ergonomically-shaped mount enables bodywork blades to be individually clamped to adapt to the shape of the surface to be worked. Lightweight stable aluminium construction.

DE
Halter - der ergonomisch geformte Halter ermöglicht die individuelle Einklemmung von Karosserieteilen an die Form der zu bearbeitenden Oberfläche. Leichte stabile Aluminiumkonstruktion.

RU
ДЕРЖАТЕЛЬ - Эргономичная форма держателя облегчает крепление полотна корпусного напильника и обеспечивает подгонку к контуру обрабатываемой поверхности. Легкая, стабильная конструкция из алюминия.



CZ
Dřevěná držadla pro klíčové pilníky, drážkovací pilníky, modelářské rašple, podkovářské rašple, strojné a ručně sekané rašple.

EN
Wooden handles for key files, grooving files, modeller's rasps, horseshoe rasps, machine- and hand-cut rasps.

DE
Holzgriffe für Schlüsselfeilen, Rillenfeilen, Modellieraspeln, Hufaspeln, maschinell und handgehauene Raspeln.

RU
Деревянные ручки для напильников для ключей, напильников с насечкой-чеккером, рашпелей для моделирования, рашпелей для обработки копыт, рашпелей с ручной и механической насечкой.



CZ
Plastové držadlo pro dílenské pilníky, frézované pilníky a pilníky na pily.

EN
Plastic handle for workshop files, milled files and saw files.

DE
Kunststoffgriff für Werkstattfeilen, gefräste Feilen und Sägefeilen.

RU
Пластиковые ручки для напильников для мастерских, напильников с фрезерованными зубьями и напильников для пил.

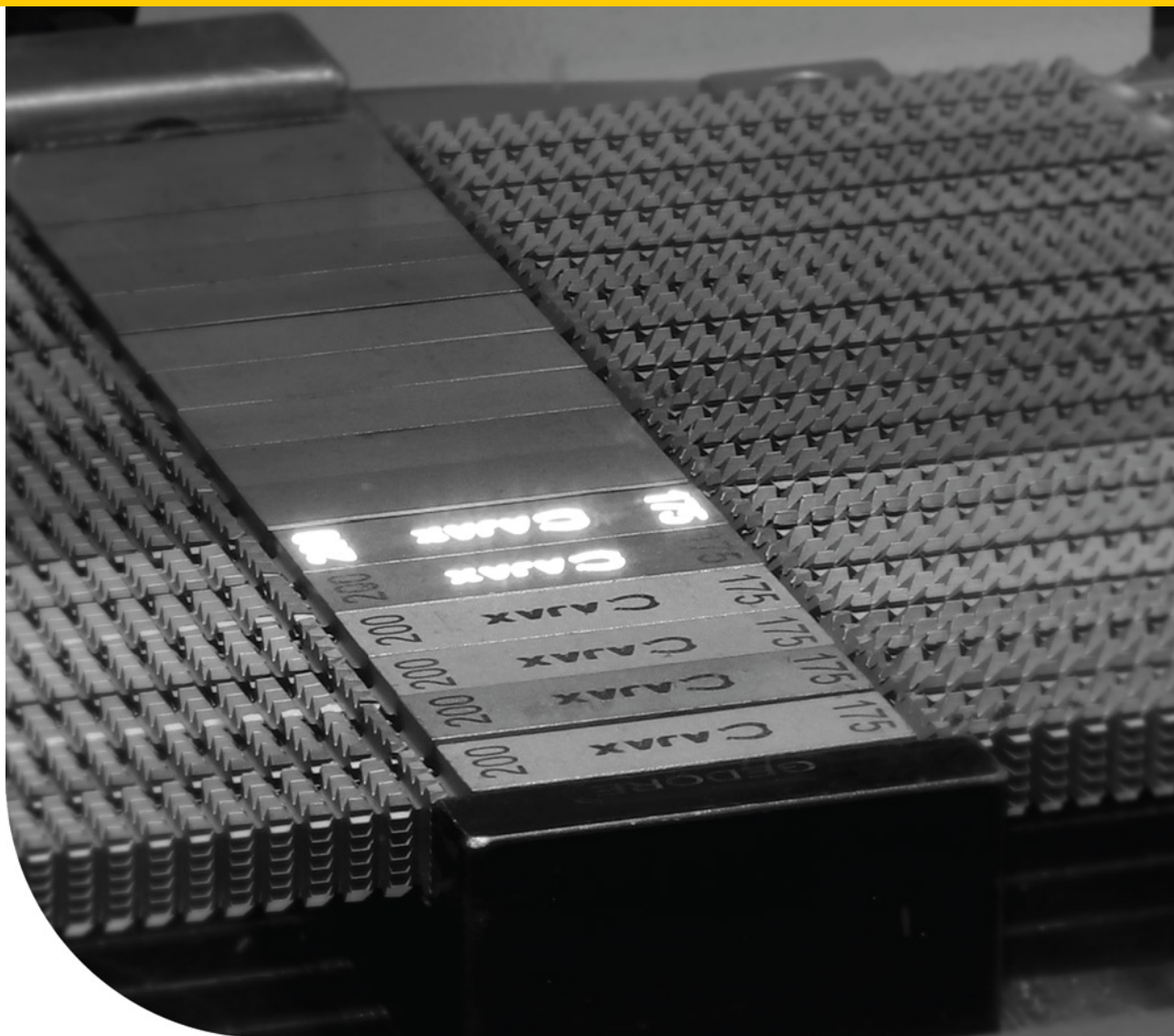

CZ

Nabízíme laserové popisování, značení a gravírování Vašich produktů. Naším profesionálním laserem můžeme popisovat i gravírovat kovy a většinu plastů.

Specifikace:
maximální popisovací pole 170 x 170 mm
maximální výška značeného profilu 90 mm
přesnost popisu 0,005 mm

EN

We offer laser marking, labelling and engraving for your products. Our professional laser can mark and engrave metals and most plastics.

Specifications:
maximum marking field 170 x 170 mm
maximum height of marked profile 90 mm
marking precision 0.005 mm

DE

Wir bieten Lasermarkierung, Kennzeichnung und Gravur Ihrer Produkte an. Mit unserem professionellen Laser können wir Metalle und die meisten Kunststoffe kennzeichnen und gravieren.

Spezifizierung:
maximales Schreibfeld 170 x 170 mm
maximale Höhe des markierten Profils 90 mm
Beschreibungsgenauigkeit 0,005 mm

RU

Мы предлагаем лазерную маркировку, нанесение надписей и гравировку вашей продукции. С нашим профессиональным лазером мы можем осуществлять маркировку и гравировку на металлах и большинстве пластмасс.

Характеристики:
максимальное поле для нанесения надписи 170 x 170 мм
максимальная высота размеченного профиля 90 мм
точность описания 0,005 мм

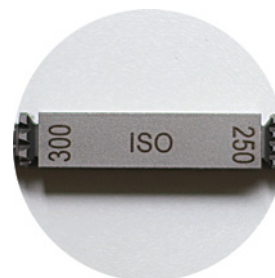



CZ

V rámci naší firmy nabízíme opracování a výrobu dílců z oceli a měkkých kovů na CNC strojích. Zabýváme se výrobou malých, středních i velkých sérií. K našemu technickému vybavení patří dlouhotočný automat, frézovací centra a CNC soustruhy.

EN

Our firm machines and manufactures steel and soft metal parts on CNC machines. We specialise in the production of small, medium and large series. Our technical facilities include a Swiss-style lathe, milling centres and CNC lathes.

DE

In unserem Unternehmen bieten wir die Bearbeitung und Herstellung von Stahl- und Weichmetallteilen auf CNC-Maschinen an. Wir fertigen kleine, mittlere und große Serien. Unsere technische Ausstattung umfasst eine Langdrehmaschine, Fräszentren und CNC-Drehmaschinen.

RU

В рамках нашей фирмы мы предлагаем обработку и производство деталей из стали и мягкого металла на станках с ЧПУ. Мы занимаемся производством небольших, средних и крупных серий. Наше техническое оборудование включает в себя высокоточное автоматическое оборудование, фрезерные центры и токарные станки с ЧПУ.



PRO EXPORT PLUS s.r.o.

V Korytech 3234/18a
100 00 Prague 10, Czech republic
IČ: 44795807
DIČ: CZ44795807

www.proexportplus.com